

Vues de profil

Schéma patte standard

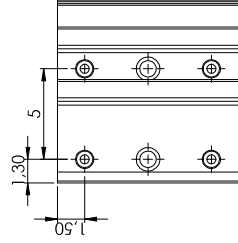

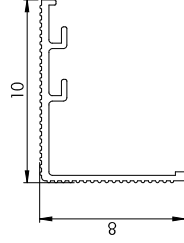
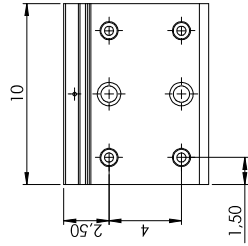
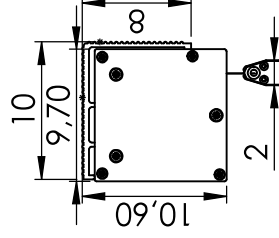

Profil carter

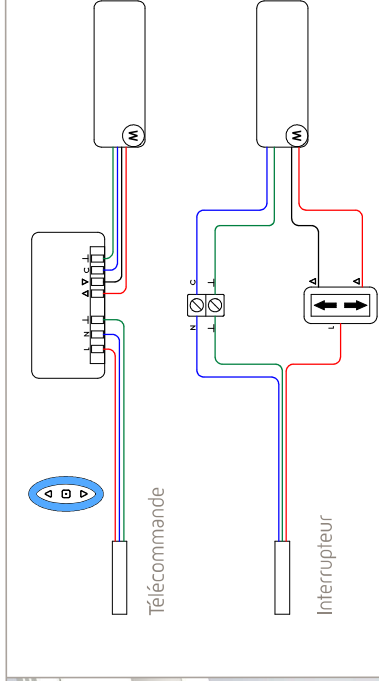

Raccordement

Schéma branchement télécommande et interrupteur



 En cas de contrôle par un automate, prévoir une coupure d'alimentation entre une commande de montée et de descente.

- L Phase
- N Neutre
- C Commun
- ↕ Montée
- ↕ Descente
- T Terre

Pattes d'écartement

Schéma patte 10 et 20 cm

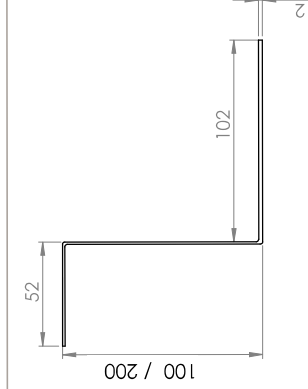

PATTES D'ÉCARTEMENT :

La paire

Référence	Dimension
OPTECAR10BSQ	10 cm
OPTECAR20BSQ	20 cm



Chemin de Beurepaire - CS 42005  
91410 DOURDAN - FRANCE  
Tel +33 (0)1 64 59 94 54

