

Universal Wall Mount
HO-RI-SR10B Black
HO-RI-SR10W White



EU-01424
 Black foot plate diam.
 35 mm for Phoenix
 version



RI-LY-CT30
 Wall bracket + 2 wheels

CT30 MKII

2-Way Passive Speaker

- Version 8 Ω: 150 W
- Version 16 Ω: 120W
- Bandwidth (-6dB): 65 Hz to 21 KHz
- Sensitivity: 91 dB / 1W @1m
- SPL MAX Level: 111 dB
- Directivity (-6dB): 120° H

- **LMF:** 1 x 6" Bass-reflex Speaker
- **HF:** 1 x 0,25" Neodym Tweeter

- 12 mm Baltic Birch Wood
- Finish polyurethane painting
- Dim. : H3297 x D235 x W206 mm / 4,5 kg

Phoenix Version: 4 pts Phoenix + 2 x M10
Speakon Version: 2 Neutrik NL4MP,
 Flange 35mm K&M + 1 x M10

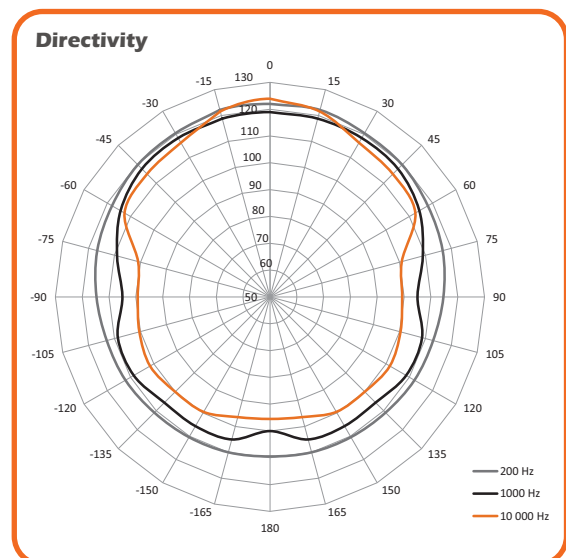
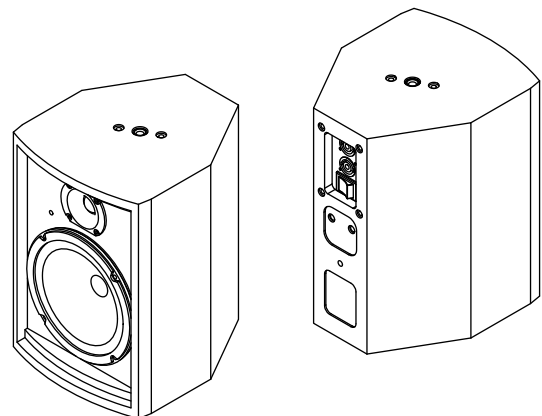

REF :

CT30MKII-PB08 : Phoenix 8 Ω Black
CT30MKII-SB08 : Speakon 8 Ω Black

CT30MKII-PB16 : Phoenix 16 Ω Black
CT30MKII-SB16 : Speakon 16 Ω Black

CT30MKII-*W** : White

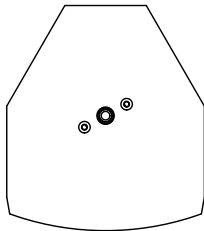
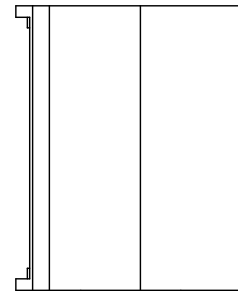
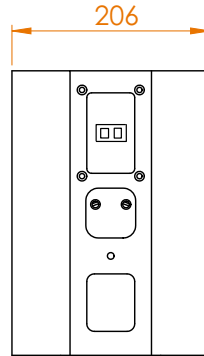
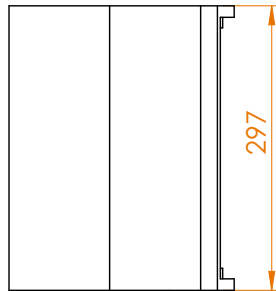
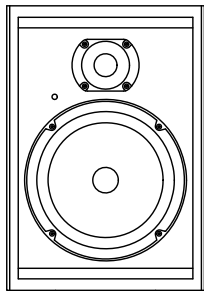
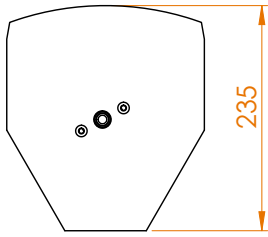

CT30 MKII PHOENIX VERSION

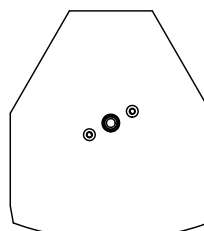
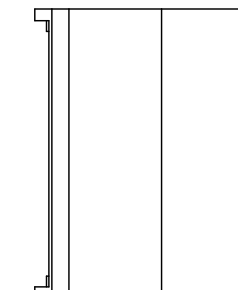
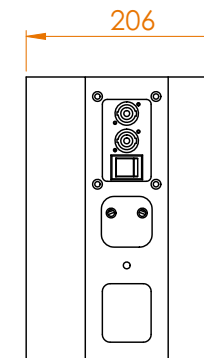
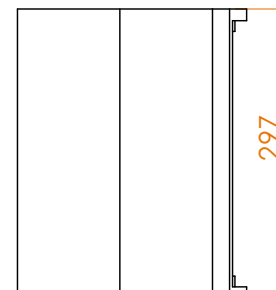
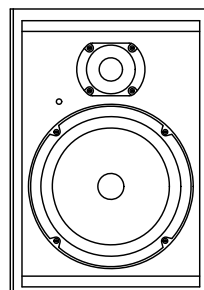
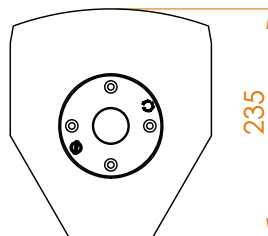

CT30 MKII SPEAKON VERSION



EU-13991 (Vibelock)

EU-01282 Tube ø35mm & M20

EU-13991 Tube ø35mm & M20