

## Overview

---

A versatile line-up for clear consistent sound.



## Features

---

- Series offers three different woofer sizes in either black or white.
- Features newly customized transducers for superb music reproduction as well as crystal clear announcements.
- Equipped with internal transformers that allow both high and low impedance drive, which can be selected by simply switching the tap on the baffle.
- Anti-Drop tab allows the speakers to be mounted temporarily in the ceiling for improved safety and ease of installation.
- A flexible carrying band makes the speakers very portable and allows carrying multiple speakers at once.
- Comes complete with O-rings and tile rails for safer and smoother installation.
- Overload protection circuit provided to protect speaker components.
- Comes with paintable speaker grilles for flexible design ideas.
- Certified to EN 54-24.

## Specifications

### General Specifications

System Type		2-way, Acoustic suspension
Components	LF	6.5" Cone
	HF	0.75" Soft dome
Frequency Range	(-10dB)	56Hz-20kHz*1
Coverage Angle (Horizontal x Vertical)		110° conical*1
Nominal Impedance		8Ω
Transformer Taps	70V	60W (83Ω), 30W (170Ω), 15W (330Ω), 7.5W (670Ω)
	100V	60W (170Ω), 30W (330Ω), 15W (670Ω)
Power Rating	NOISE	75W
	PGM	150W
	MAX	300W
Sensitivity (1W, 1m)		86dB SPL*1
Maximum SPL (Calculated, 1m)		111dB SPL*2
Connectors		1 x Ceramic terminal block (3P) (input: +/-, Earth)
Material, Finish, Color		Black, White
Dimensions (W x H x D)		Ø286mm x 241mm (11.3" x 9.5")
Net Weight		4.4kg (9.7lbs)
Packaging		Pair
IP Rated		IP32
Cutout Size		Ø247mm (Ø9.8")
Certificate		CE, RoHS, EN54-24

\*1 Half space (2π)

\*2 Calculated based on power rating and sensitivity, exclusive of power compression

### Accessories

Included Accessories	O-ring, Tile Rail, Cutout Template
----------------------	------------------------------------

**Dimensions**

Unit: mm (inch)

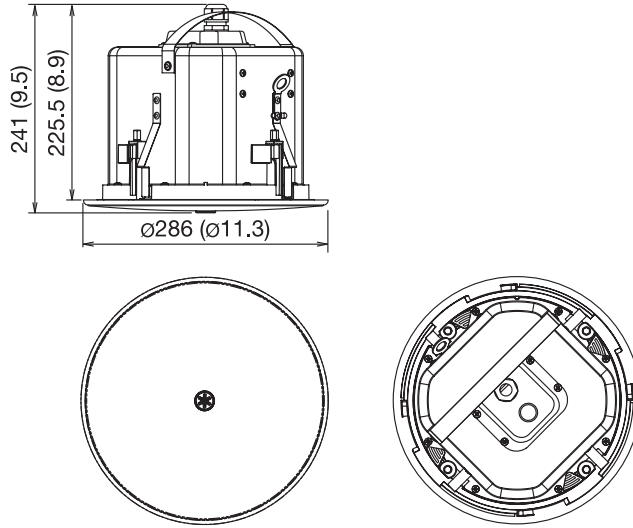

**O-ring**

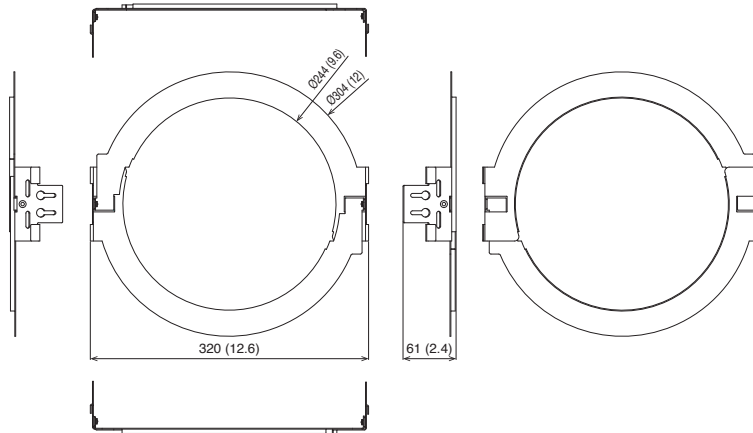

**Tile Rail**

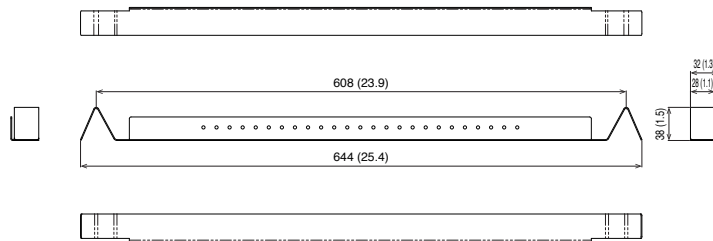

## Architectural and Engineering Specifications

---

The loudspeaker shall be of in-ceiling design, a 2-way acoustic suspension type and shall have a back can. The loudspeaker shall consist of a 6.5" (16cm) cone driver for low frequency and a 0.75" (2cm) soft dome tweeter for high frequency. The loudspeaker shall be equipped with internal transformers that allow both high-impedance and low impedance drive. The Anti-Drop tab shall be provided for improved safety and ease of installation that allows the loudspeaker to be mounted temporarily in the ceiling. The flexible carrying band shall be provided for improved portability. The power rating shall be set by switching a transformer tap on the baffle as follows: 60W/30W/15W in 100V line; 60W/30W/15W/7.5W in 70V line; and 150W into 8 ohms. The loudspeaker shall be capable of meeting the following performance criteria: The measured sensitivity shall be 86dB SPL (at 1W, 1m, in half-space); The maximum SPL shall be 111dB SPL (at 1m); The frequency range shall be 56Hz-20kHz (10dB below rated sensitivity, in halfspace); The nominal coverage angle shall be 110° polar conical (average 500Hz-4kHz). The loudspeaker shall be provided for an overload protection circuit to protect network and transducers. The loudspeaker shall comply with dust and water resistance rating of IP32. The 4-pin Euroblock connector shall be provided for an input and a loop-thru. The back can shall be constructed of 1mm-thick black-painted steel and the baffle of HIPS. The grille shall be constructed of 0.6mm-thick steel and the trim ring of ABS, with an aperture ratio of 51%. The grille shall have the following color variation: black-painted (VXC6-VA) or whitepainted (VXC6-VAW). Overall front face diameter of the loudspeaker shall not exceed 286mm (11.3"), overall depth from the bottom of the ceiling shall not exceed 241mm (9.5"), and shall weigh no more than 4.4kg (9.7lbs). The loudspeaker shall have included accessories as follows: The O-rings and the tile rails shall be included for safer and smoother installation. The loudspeaker shall be equipped with an eyelet for secondary safety wire usage. EN54-24 certified. The loudspeaker shall be the Yamaha VXC6-VA or VXC6-VAW.

## On-axis Frequency Response

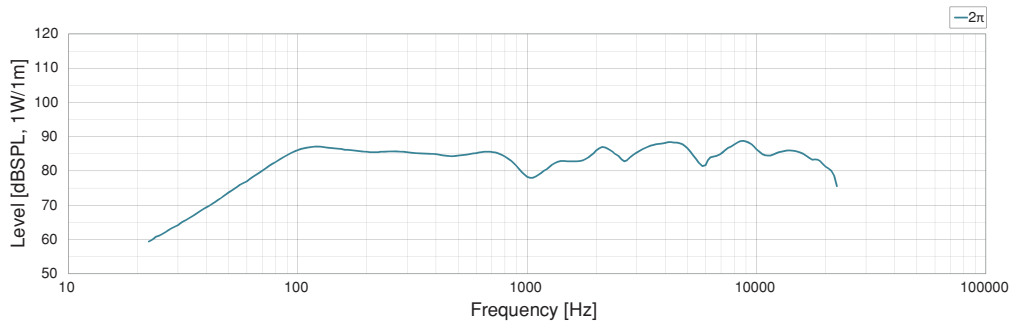

## Beamwidth

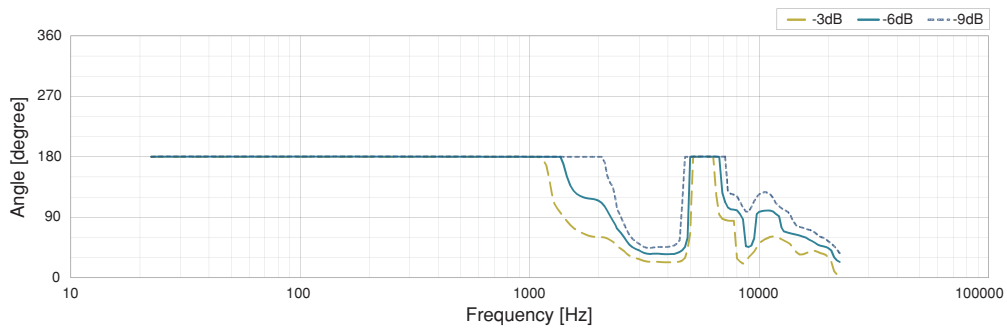

## Directivity Index

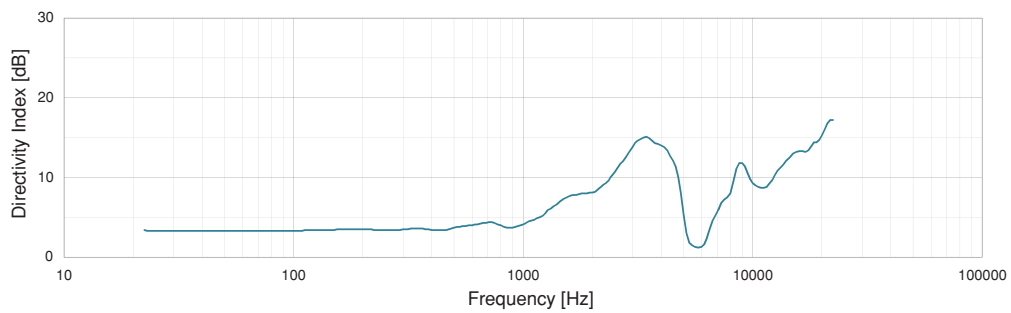

## Polar Plots

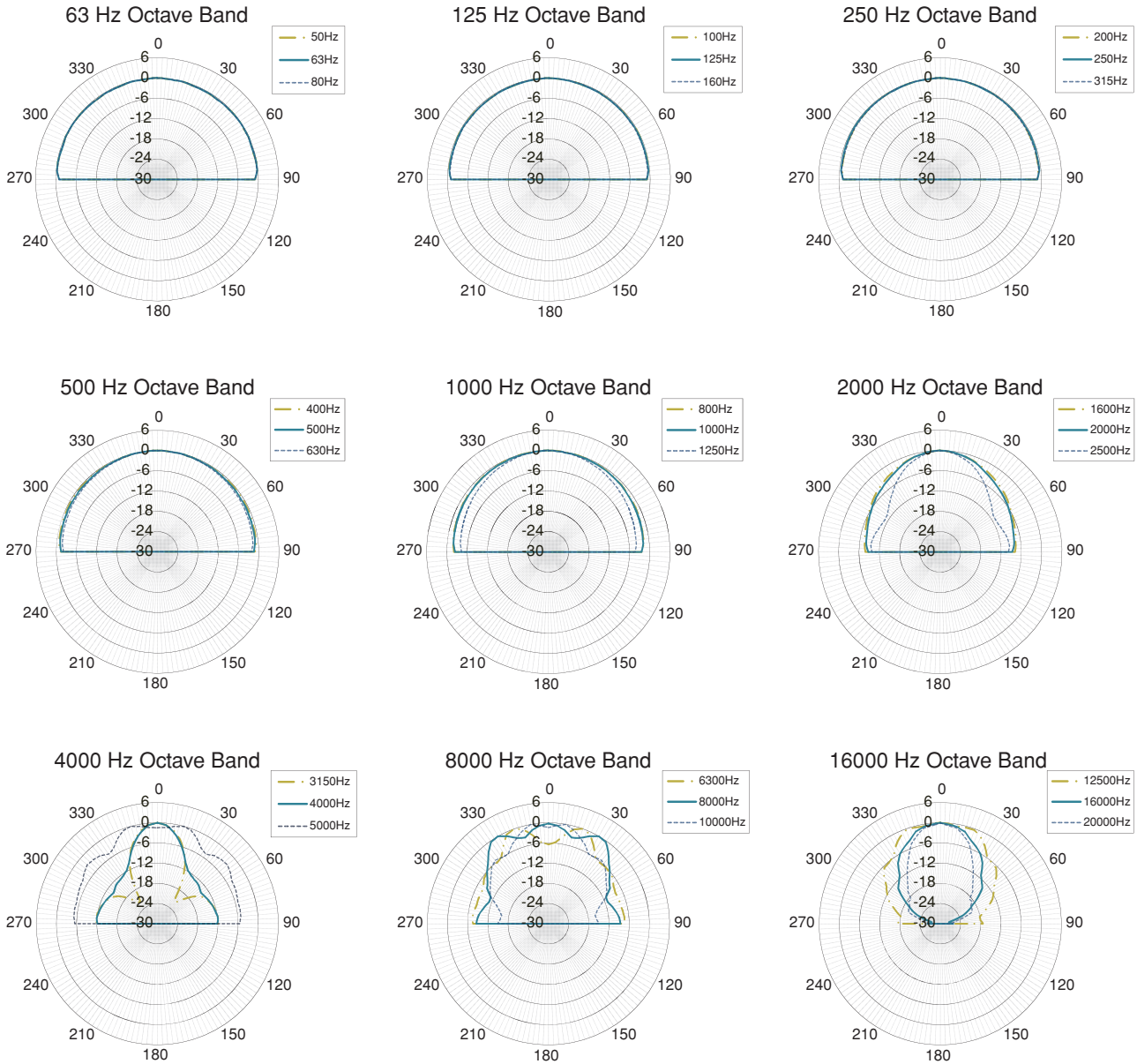

\*All information subject to change without notice.

\*All trademarks and registered trademarks are property of their respective owners.

Created in March, 2020