

Overview

A versatile line-up for clear consistent sound.



Features

- Series offers three different woofer sizes in either black or white.
- Features newly customized transducers for superb music reproduction as well as crystal clear announcements.
- Designed with optimized bass-reflex tuning to offer a firm, tight low-end.
- Equipped with internal transformers that allow both high and low impedance drive, which can be selected by simply switching the tap on the baffle.
- Anti-Drop tab allows the speakers to be mounted temporarily in the ceiling for improved safety and ease of installation.
- A flexible carrying band makes the speakers very portable and allows carrying multiple speakers at once.
- Comes complete with O-rings and tile rails for safer and smoother installation.
- Overload protection circuit provided to protect speaker components.
- Comes with paintable speaker grilles for flexible design ideas.
- Certified to EN 54-24.

Specifications

General Specifications

System Type	Full-range, Acoustic suspension	
Components	4" full-range	
Frequency Range	(-10dB)	80Hz-20kHz*1
Coverage Angle (Horizontal x Vertical)	130° conical*1	
Nominal Impedance	8Ω	
Transformer Taps	70V	30W (170Ω), 15W (330Ω), 7.5W (670Ω), 3.8W (1.3kΩ)
	100V	30W (330Ω), 15W (670Ω), 7.5W (1.3kΩ)
Power Rating	NOISE	30W
	PGM	60W
	MAX	120W
Sensitivity (1W, 1m)	87dB SPL ¹	
Maximum SPL (Calculated, 1m)	108dB SPL ²	
Connectors	1 x Euroblock (4P) (Input: +/-, Loop Thru: +/-)	
Material, Finish, Color	Black, White	
Dimensions (W x H x D)	Ø225mm x 232mm (8.9" x 9.1")	
Net Weight	2.6kg (5.7lbs)	
Packaging	Pair	
Cutout Size	Ø186mm (Ø7.3")	
Certificate	CE, RoHS, EN54-24	

*1 Half space (2π)

*2 Calculated based on power rating and sensitivity, exclusive of power compression

Accessories

Included Accessories	O-ring, Tile Rail, Cutout Template
----------------------	------------------------------------

Dimensions

Unit: mm (inch)

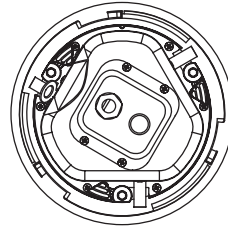
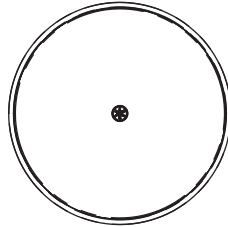
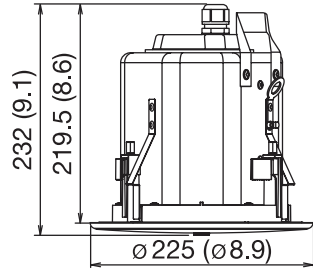

O-ring

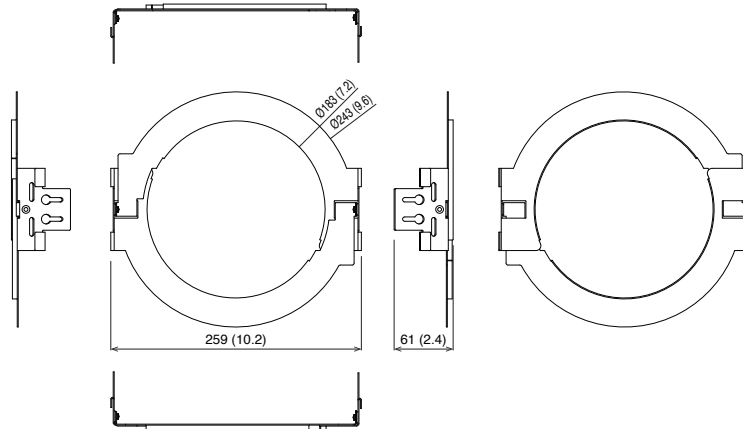

Tile Rail

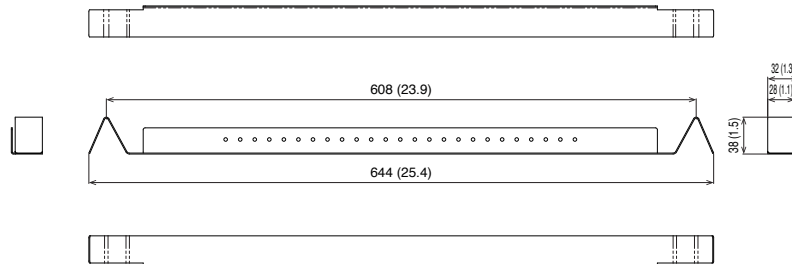

Architectural and Engineering Specifications

The loudspeaker shall be of in-ceiling design, a full-range bass-reflex type and shall have a back can. The loudspeaker shall consist of a 4" (10cm) cone driver. The loudspeaker shall be equipped with internal transformers that allow both high-impedance and low-impedance drive. The Anti-Drop tab shall be provided for improved safety and ease of installation that allows the loudspeaker to be mounted temporarily in the ceiling. The flexible carrying band shall be provided for improved portability. The power rating shall be set by switching a transformer tap on the baffle as follows: 30W/15W/7.5W in 100V line; 30W/15W/7.5W/3.8W in 70V line; and 60W into 8 ohms. The loudspeaker shall be capable of meeting the following performance criteria: The measured sensitivity shall be 87dB SPL (at 1W, 1m, in half-space); The maximum SPL shall be 108dB SPL (at 1m); The frequency range shall be 80Hz-20kHz (10dB below rated sensitivity, in half-space); The nominal coverage angle shall be 130° polar conical (average 500Hz-4kHz). The loudspeaker shall be provided for an overload protection circuit to protect network and transducers. The loudspeaker shall be provided for an overload protection circuit to protect network and transducers. The loudspeaker shall comply with dust and water resistance rating of IP32. The 4-pin Euroblock connector shall be provided for an input and a loop-thru. The back can shall be constructed of 1mm-thick black-painted steel and the baffle of HIPS. The grille shall be constructed of 0.6mm-thick steel and the trim ring of ABS, with an aperture ratio of 51%. The grille shall have the following color variation: black-painted (VXC4-VA) or white-painted (VXC4-VAW). Overall front face diameter of the loudspeaker shall not exceed 225mm (8.9"), overall depth from the bottom of the ceiling shall not exceed 232mm (9.1"), and shall weigh no more than 2.6kg (5.7lbs). The loudspeaker shall have included accessories as follows: The O-rings and the tile rails shall be included for safer and smoother installation. The loudspeaker shall be equipped with an eyelet for secondary safety wire usage. EN54-24 certified. The loudspeaker shall be the Yamaha VXC4-VA or VXC4-VAW.

On-axis Frequency Response

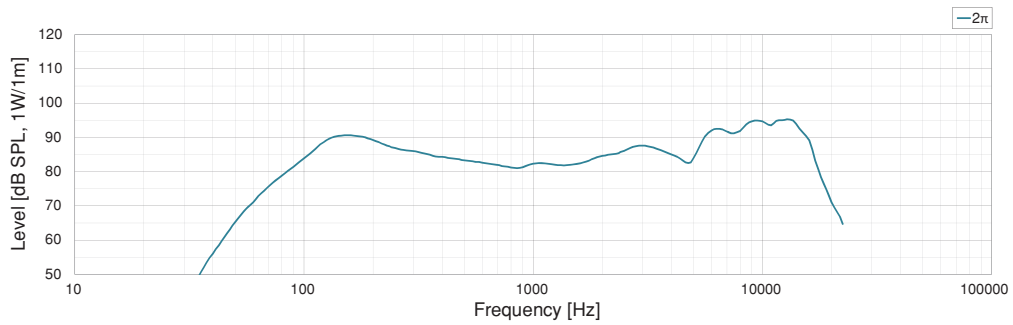

Beamwidth

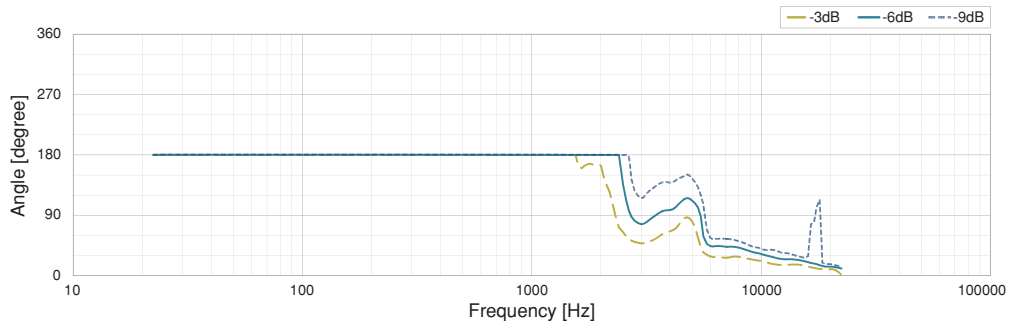

Directivity Index

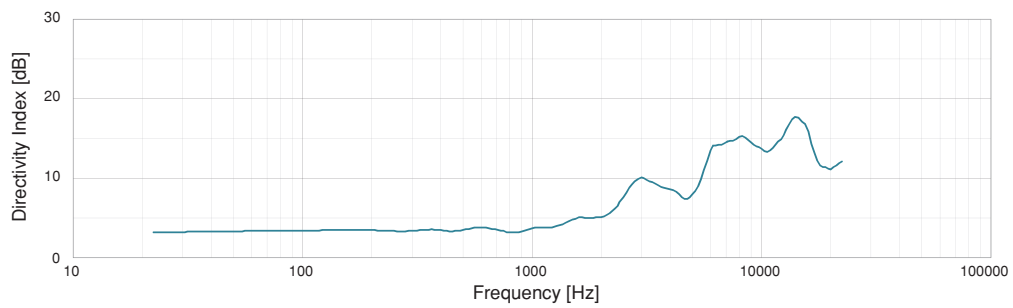

Polar Plots

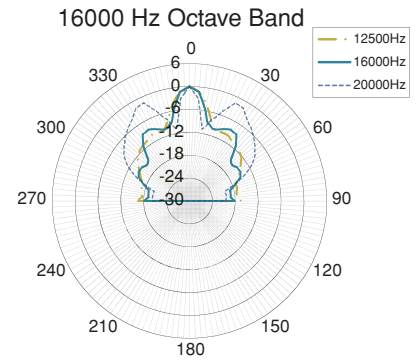
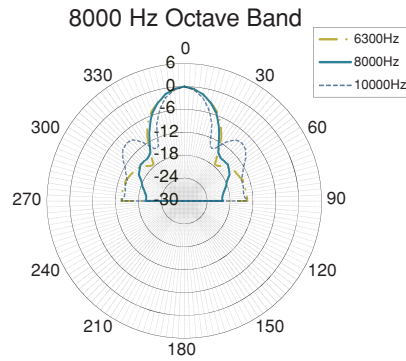
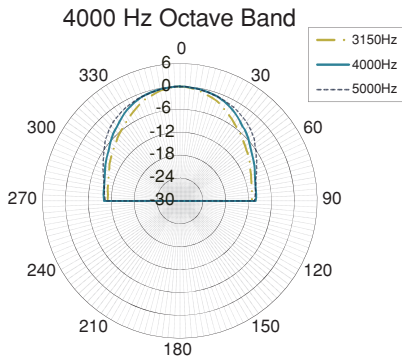
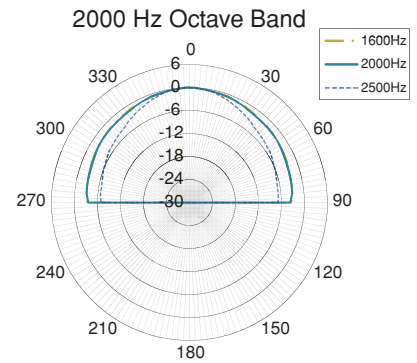
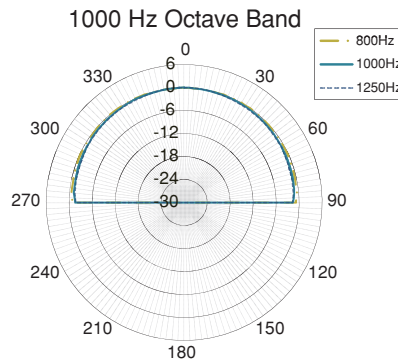
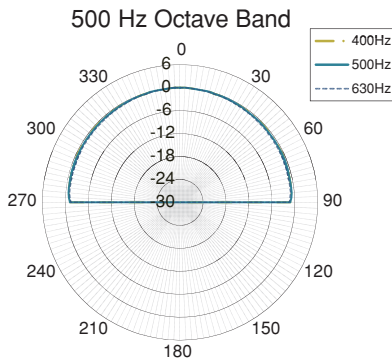
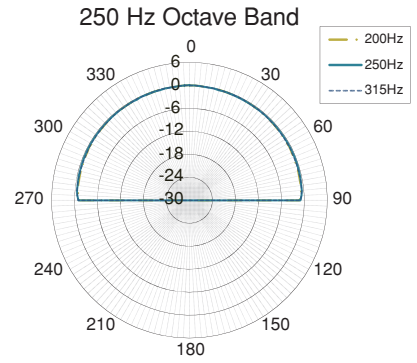
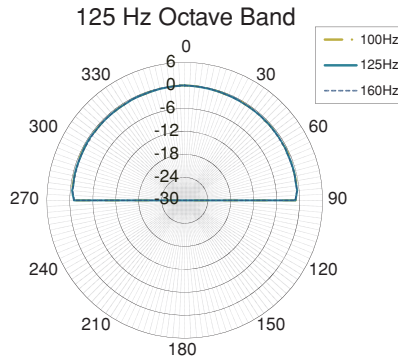
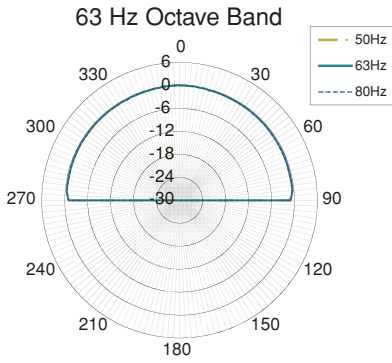

*All information subject to change without notice.

*All trademarks and registered trademarks are property of their respective owners.

Created in March, 2020