

EIKI

Owner's manual

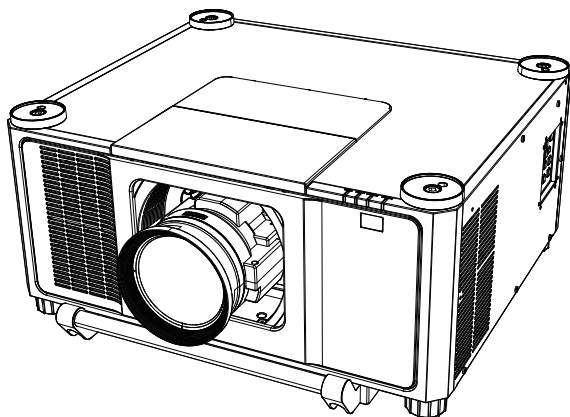

Multimedia Projector

V2200

Features and Design

This Projector is designed with the most advanced technology for durability and ease of use. This projector utilizes built-in multimedia features, a palette of 1.07 billion colors and matrix liquid crystal display (LCD) technology.

Simple Computer System Setting

The projector has the Multi-scan system to conform to almost all computer output signals quickly. Up to 4K resolution can be accepted.

Useful Functions for Presentations

The digital zoom and focus function allows you to focus on the crucial information during a presentation.

-Lens shift feature provides greater installation flexibility.

Brightness Control

Laser control selection allow you to setting the suitable brightness for different usage.

Logo Function

The Logo function allows you to customize the screen logo.

Multilanguage Menu Display

The screen menu of the projector is available in 26 languages: English, German, French, Italian, Spanish, Polish, Swedish, Dutch, Portuguese, Japanese, Simplified Chinese, Traditional Chinese, Korean, Russian, Arabic, Turkish, Finnish, Norwegian, Danish, Indonesian, Hungarian, Czech, Kazakh, Vietnamese, Thai, Farsi.

Maintenance-Free

With long life time laser light source and excellent dust resistant system, there is no need to change the Light source and filter.

Security Function

The Security function helps you to ensure security of the projector. With the Key lock function, you can lock the operation on the control panel or remote control. PIN code lock function prevents unauthorized use of the projector.

LAN Network Function

This projector is loaded with the wired LAN network function. You can operate and manage the projector via network.

Auto Setup Function

This function enables input source search and auto PC adjust by simple pressing the AUTO button on the remote control.

Colorboard Function

At the time of simple projection on the colored wall, you can get the close color image to the color image projected on a white screen by selecting the similar color to the wall color from the preset four colors.

Power Management

The Power management function would reduces power consumption to save the energy.

✓ Note:

- The screen menu and images in the manual may slightly differ from the real product.
- The manual is subject to change without prior notice.



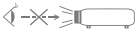

Table of contents

Features and Design	2	Standby mode.....	53
Table of contents.....	3	High land function.....	53
Safety operation guideline.....	4	Cooling fast setting	53
Compliance.....	19	Contrast optimization	53
Accessories	20	Laser Control	54
Overview		Keylock function.....	54
Name and function of your projector		Remote control code setting.....	54
Front/top	22	HDMI setup.....	54
Rear/Side.....	22	Edge blending.....	55
Bottom	22	Stage light control.....	56
Terminal	23	Timing switch	56
Control Panel.....	24	Expand	
Remote controller	25	Language.....	57
Remote controller operation range	26	Auto Setup.....	57
Install battery of remote controller	27	Keystone.....	58
		Logo.....	60
Installation		Security.....	61
Installation		Power Management.....	62
Lens installation	29	Lens Adjust.	62
Set up your projector	33	Test pattern.....	62
Lens shift adjustment.....	34	Network.....	63
Adjustment pad.....	35	Factory Default	63
Connect the AC power cord.....	36	Memory Viewer	
Connection to equipment		Memory Viewer.....	64
Connection to computer.....	37	Info.	
Connection to video and audio equipment	38	Information.....	65
		Description on using useful function	
Operation		Network control operation.....	67
Basic operation		Network display function.....	72
Power on your projector.....	40	Memory Viewer function	75
Power off your projector.....	41	USB Display function	77
Focus function	42	Maintenance	
Zoom function.....	42	Status light indicator	80
Lens shift function.....	42	Clean the lens.....	81
Keystone adjustment	43	Clean casing of your projector.....	81
How to use the OSD.....	44	Appendix	
Menu operation.....	44	Troubleshooting	83
Menu item overview.....	45	Light indicator status.....	85
Remote controller operation	46	Compatible computer screen.....	86
Input selection		Terminal configuration.....	87
Input select	47	Menu Tree.....	88
Display		Technical Specifications.....	93
Auto PC Adjusting.....	48	Information of optional lens.....	94
Manual computer adjustment	49	Dimensions.....	95
Color Adjust		PIN code memorandum.....	96
Color Adjust	51		
Setting			
Direct Power On	53		

Safety operation guideline

Safety instructions



This document and your projector employ certain symbols to illustrate how to use your projector safely. They are described below: Please get yourself familiar with them before going through this document.

 <p>Caution</p>	<p>Ignoring messages indicated by this symbol may lead to personal injuries or deaths due to human errors.</p>
 <p>Note</p>	<p>Ignoring messages indicated by this symbol may lead to personal injuries or property damage.</p>
	<p>High voltage inside with risks of electric shock.</p>
	<p>Do not look into the lens while the light source is ON. The strong light from the light source may cause damage to your eyesight. Do not stare into the beam which may be harmful to the eyes.</p>
	<p>Do not place anything in front of the lens while the projector is operating. Things placed in front of the lens may overheat and burn or start a fire. If you want to temporarily stop the projected image, use the Blank key on the remote control.</p>

Please read this manual carefully before installing and operating your projector.

Your projector comes with a lot of convenient features and functions. You may make the most of these features and keep your projector in good working conditions by using it correctly. Invalid operation of your projector may not only shorten its life cycle but also may lead to product failure, fire, or other incidents.

In case of any operation abnormality, refer to this manual to check your operation and connections and try solutions given in the “Troubleshooting” section at end of this manual. If the problem persists, call your dealer or our service center.

<div style="text-align: center;">  <div style="border: 1px solid black; padding: 5px; display: inline-block;"> <p>Caution</p> <p>Danger of electric shock DO NOT open this.</p> </div>  </div>
<p>Note: DO NOT remove the casing (or back cover) as it may result in electric shock. Users shall not execute any maintenance work on components within your projector except replacing lamps. Call qualified maintenance personnel in case of any maintenance requirements.</p>



High voltage inside with risks of electric shock.



Operation and maintenance tips about these components.

Safety operation guideline

Warning:

DONOT leave the projector in the rain or expose it to moisture environment to prevent fire or electric shock.
The proposed plug should not be used in an extension cord outlet or other outlet unless the pin is fully plugged in.



Warning:

This projector is an RG3 product. The projector is for professional use and must be installed in location where safety is assured. For this reason, be sure to consult your dealer as installation and attachment/detachment of the lens unit must be performed by a professional service personnel. Never try to install the projector by yourself. This may result in visual impairment etc.



Caution:

Avoid displaying stationary images for a prolonged period of time.
Doing so can result in these images being temporarily sustained on the surface of the LCD panel.
If this should happen, continue to use your projector. The static background from previous images will disappear..



Caution

Safety precautions:

- GROUND your projector.
- Lens of your projector projects strong light. DO NOT look at the light beam directly. You may get your eyesight hurt. This is especially the case with children.
- Unplug the AC power plug if your projector will not be used for long time.
- DO NOT overload the socket of power cord as it may lead to fire or electric shock. DO NOT subject the power cord to any object. DO NOT place your projector in locations where its power cord may become damaged by treading by passersby.
- Disconnect the power plug before cleaning your projector. DO NOT apply liquid or sprays to your projector. DO NOT wipe your projector with wet cloth.
- Please follow warnings and instructions given in labels attached to your projector. Unplug your projector when your projector is exposed to thunderstorm weather, is unmanned, or not in use for long periods to prevent damage caused by lightning and power surges.
- DO NOT use accessories without recommendation by the manufacturer as it may result in potential risks.

Safety operation guideline

Disposing of your used product



In the European Union

EU-wide legislation as implemented in each Member State requires that used electrical and electronic products carrying the mark (left) must be disposed of separately from normal household waste. This includes projectors and their electrical accessories. When you dispose of such products, please follow the guidance of your local authority and/or ask the shop where you purchased the product.

After collecting the used products, they are reused and recycled in a proper way. This effort will help us reduce the wastes as well as the negative impact to the human health and the environment at the minimum level.

The mark on the electrical and electronic products only applies to the current European Union Member States.

Outside the European Union

If you wish to dispose of used electrical and electronic products outside the European union, please contact your local authority and ask for the correct method of disposal.



For EU:

The crossed-out wheeled bin implies that used batteries should not be put to the general household waste! There is a separate collection system for used batteries, to allow proper treatment and recycling in accordance with legislation.

According the EU directive 2006/66/EC, the battery can't be disposed improperly. The battery shall be separated to collect by local service.

Warning:

This equipment is compliant with Class A of CISPR 32. In a residential environment this equipment may cause radio interference.

Safety operation guideline



Caution

Precautions on air outlet / air intake:

- Keep adequate clearance around your projector for its ventilation and cooling. See figure below for the least clearance requirements. The least clearance is a **MUST** when your projector is placed within a cabinet or other closed environment.

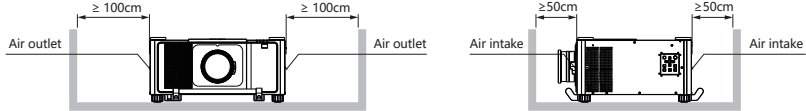

- **DO NOT** cover the air outlet of your projector. Poor ventilation not only shorten life cycle of your projector but also may lead to risks.
- Slots and openings at rear and bottom of your projector are designed for ventilation. Keep your projector from overheated to ensure its steady operation.
- **DO NOT** cover the air outlet with cloth or other objects. **DO NOT** place your projector on the surface of bed, sofa, carpets, or similar object as this may block the air outlets at its bottom.
- **DO NOT** place your projector in closed environment, e.g. a bookcase, unless it is well ventilated.
- Keep any matter from falling in your projector through the air outlets as they may touch high voltage parts and lead to fire or electric shock by short circuits. **DO NOT** splash liquid to your projector.



Note:

Precautions on location of your projector:

- Place your projector in a proper location or it may result in fire.
- **DO NOT** expose your projector in rain or high humidity environments or it may result in fire or electric shock. **DO NOT** place your projector near water or splashing water. **DO NOT** place any water container, e.g. flower vase, atop your projector.
- **DO NOT** place your projector in environments of soot, moisture or smoke, e.g. your kitchen, or it may lead to product failure or accidents. Your projector may be damaged by contact with oil or chemicals.
- **DO NOT** place your projector near exhaust pipe or air conditioning equipment.
- **DO NOT** place your projector near radiator or heating pipes.
- **DO NOT** place your projector atop unstable truck, rack, or table. It may fall of the surface and lead to personal injuries and property damages. Please use cart or rack recommended by the manufacturer or included with your product. Please follow steps given in installation guideline included with the wall and ceiling mount racks for installation. Use installation components approved by the manufacturer.
- Be careful when moving your projector with cart. Abrupt stops, pushing too hard and rugged surfaces may topple your projector and the cart together.

Safety operation guideline

Notes



Caution

Safety precautions:

- GROUND your projector.
- Lens of your projector projects strong light. DO NOT look at the light beam directly. You may get your eyesight hurt. This is especially the case with children.
- Do not use optical instruments (such as magnifying glasses and reflectors) to peer into the light of the source. Because this can cause visual impairment.
- The operator should control access to the beam within the hazard distance or install the product at a height that prevents the observer's eyes from being exposed within the hazard distance.
- Adjust from the side or back of the projector. If adjusted from the front, the eyes may be exposed to bright light, which can cause eye damage.
- Do not place any object (magnifying glass, etc.) within reach of the projector's light. The light path projected from the mirror is divergent. Therefore, any type of abnormal object that can change the light can cause accidents such as fire or eye injury.
- Do not allow children to operate the projector alone. Children operating the projector should be carefully supervised by an adult present.
- The following illustration marked near the lens on the case indicates that the risk category of this projector is classified as IEC/EN 62471-5:2015 risk group 3.

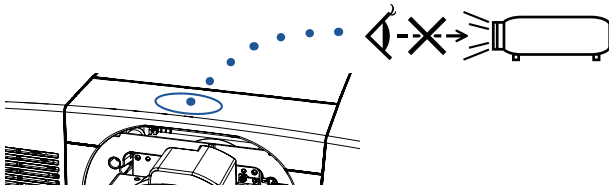

- Unplug the AC power plug if your projector will not be used for long time.
- DO NOT overload the socket of power cord as it may lead to fire or electric shock. DO NOT subject the power cord to any object. DO NOT place your projector in locations where its power cord may become damaged by treading by passersby.
- Disconnect the power plug before cleaning your projector. DO NOT apply liquid or sprays to your projector. DO NOT wipe your projector with wet cloth.
- Please follow warnings and instructions given in labels attached to your projector. Unplug your projector when your projector is exposed to thunderstorm weather, is unmanned, or not in use for long periods to prevent damage caused by lightning and power surges.
- DO NOT use accessories without recommendation by the manufacturer as it may result in potential risks.

Safety operation guideline



Caution

Precautions on air outlet:

- Keep adequate clearance around your projector for its ventilation and cooling. See figure below for the least clearance requirements. The least clearance is a **MUST** when your projector is placed within a cabinet or other closed environment.

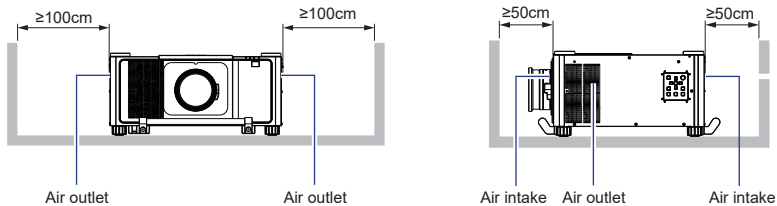

If multiple projectors are used for multi-screen projection, sufficient intake and exhaust space should be left around the projector. When the intake and exhaust ports are blocked, the temperature inside the projector will increase, which can lead to failure.



- DO NOT cover the air outlet of your projector. Poor ventilation not only shorten life cycle of your projector but also may lead to risks.
- Slots and openings at rear and bottom of your projector are designed for ventilation. Keep your projector from overheated to ensure its steady operation.
- DO NOT cover the air outlet with cloth or other objects. DO NOT place your projector on the surface of bed, sofa, carpets, or similar object as this may block the air outlets at its bottom.
- DO NOT place your projector in closed environment, e.g. a bookcase, unless it is well ventilated.
- Keep any matter from falling in your projector through the air outlets as they may touch high voltage parts and lead to fire or electric shock by short circuits. DO NOT splash liquid to your projector.

Safety operation guideline



Note:

Precautions on using your projector:

- DO NOT project the same image for long time as residual images may be left in the panel. This is a property of LCD panel.
- Use power as indicated in tags attached to your projector. If you have doubts over available power type, consult your dealer or local power company first.
- DO NOT open or remove the casing for maintenance as this may lead to electric shock or other damages. Call qualified maintenance personnel in case of any maintenance requirements.
 - In case of the following, unplug the power cord and call qualified maintenance personnel for service immediately:
 - a. Damaged or broken power cord or plug
 - b. Liquid splashed in your projector
 - c. Your projector exposed to rain or water
 - d. If your projector fails to work as expected by following operation instructions, adjust it according to given instructions. Other invalid operations may damage your projector, which requires the technician to spend more time before returning it back to normal.
 - e. The projector falls off to ground or its casing is damaged.
 - f. In case of any abnormal change in your projector during its use, then maintenance services would be required.
- In case components replacement is required, make sure the replacements have been approved by the manufacturer and features the same with the one being replaced. Use of unauthorized parts may lead to fire, electric shock or personal injury.
- After the completion of maintenance or repair work, get the maintenance personnel to run routine safety check to ensure your projector's safety operation status.

Information for users in the European Union

This is a device to project images onto a screen, etc., and is not intended for use as indoor lighting in a domestic environment.

Directive 2009/125/EC.

About High Altitude mode

- Set [HIGH ALTITUDE] to [ON] in the Setting menu when using the projector at altitudes approximately 1400 meters or higher.
Using the projector at altitudes approximately 1400 meters or higher without setting to [HIGH ALTITUDE] can cause the projector to overheat and the projector could shut down. If this happens, wait a couple minutes and turn on the projector.
- Using the projector at altitudes less than approximately 1400 meters and setting it to [ON] can cause the light module to overcool, causing the image to flicker. Switch [FAN MODE] to [OFF].
- Using the projector at altitudes approximately 1700 meters or higher can shorten the life of optical components such as the light module.

Safety operation guideline

Light Module

- A light module containing multiple laser diodes is equipped in the product as the light source.
- These laser diodes are sealed in the light module. No maintenance or service is required for the performance of the light module.
- End user is not allowed to replace the light module.
- Contact qualified distributor for light module replacement and further information.
- Outline of laser emitted from the built-in light module:
Wavelength: 455 nm
Maximum power: 390W



Note:

Please heed all precaution for safety

To install the projector

- This projector is an RG3 product. The projector is for professional use and must be installed in location where safety is assured. For this reason, be sure to consult your dealer as installation and attachment/detachment of the lens unit must be performed by a professional service personnel. Never try to install the projector by yourself. This may result in visual impairment etc.
- For planning the layout of the projector, make sure to take safety measures instructed on the installation manual.
- In order to refuse danger, install either a wall outlet within easy reach for pulling out the power plug in emergency or a device as a breaker to shut down the power supply to the projector.
- Take safety measures preventing human eyes from entering the RG3 zone.
- Considering the installation place, select an appropriate lens and secure safety zone that is determined for each lens. For operation on the powered projector as light adjustment, make sure appropriate safety measures have been taken.
- Check the validity of taken security measures if appropriate safety zone based on the installed lens is secured.
Periodically check the validity and keep these results.
- Educate the administrator of the projector (operators) about safety before starting to operate the projector.

To use the projector

- Instruct the administrator of the projector (operators) to perform inspections before powering on the projector. (Including the safety check against emitted light by the projector)
- Instruct the administrator of the projector (operators) to be in circumstances able to control the projector whenever the projector is powered on for an emergency.
- Instruct the administrator of the projector (operators) to keep the installation manual, user's manual and inspection records to a place where they can take these documents out easily.
- Instruct them to clarify if the projector is conformed to standards of each country and region.

Safety operation guideline

Laser safety caution

- This product is classified as Class 1 of IEC 60825-1:2014.
- Obey the laws and regulations of your country in relation to the installation and management of the device.
- Regarding the installation and management of the equipment, please comply with the relevant laws and regulations of your country.
- The laser module is equipped in this product. Use of controls or adjustments of procedures other than those specified herein may result in hazardous radiation exposure.



Class 1 laser product of IEC 60825-1:2014

- No direct exposure to the beam.
- Use of controls or adjustments or performance of procedures other than those specified herein may result in hazardous radiation exposure.

Risk groups

This projector is classified as either IEC/EN 62471-5:2015 risk group 3, which is intended for professional use and must be installed by professional installer to ensure safety.



WARNING

RG3 PRODUCT OF IEC/EN 62471-5:2015

- When classified as RG3, this projector is for professional use and must be installed in location where safety is assured. For this reason, be sure to consult your dealer as installation must be performed by a professional installer. Never try to install the projector by yourself. This may result in visual impairment etc.
- No direct exposure to the beam shall be permitted, RG3 IEC/EN 62471-5:2015.
- Do not look into the projector's lens. Serious damage to your eyes could result.
- Operators shall control access to the beam within the hazard distance or install the product at the height that will prevent exposures of spectators' eyes within the hazard distance.
- When turning on the power, operate from the side or rear of the projector (outside the hazard zone). Also, when turning on the power, make sure no one within the projection range is looking at the lens.

Safety operation guideline

Radiation Zone (HD: Hazard Distance)

- The below table describes the radiation zone of emitted light by the projector that is classified as Risk Group 3 (RG3) of IEC/EN 62471-5 First edition 2015.

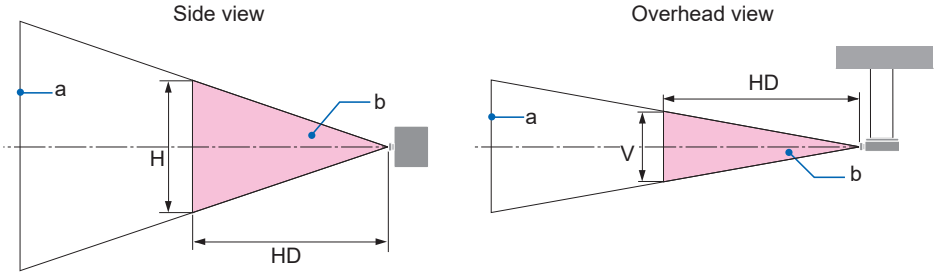

a: Screen / b: Hazard zone

About the precautionary zone

By providing a precautionary zone or physical barriers, it is possible to prevent human eyes from entering the hazard zone.

When the manager of the projector (operator) cannot prevent spectators from entering the hazard zone such as in public facilities, it is recommended to secure a space of 1 m or more from the hazard zone as “the precautionary zone” for the safety of the spectators. When installing the projector overhead, it is recommended that the distance between the floor and the hazard zone be at least 3 m in the vertical direction.

[In the United States](#), provide a horizontal distance of 2.5 meters from the hazard zone.

[When installthe projector overhead](#), provide a vertical distance of 3 meters from the floor to the hazard zone.

Installation example considering the precautionary zone

① Floor or desktop installation example

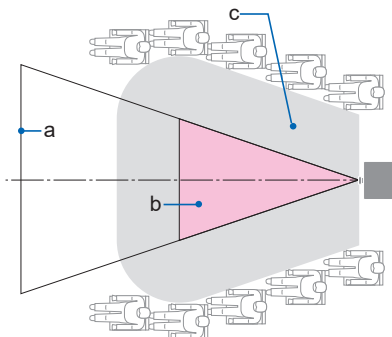

a: Screen / b: Hazard zone / c: Precautionary zone / d: floor

② Ceiling installation example

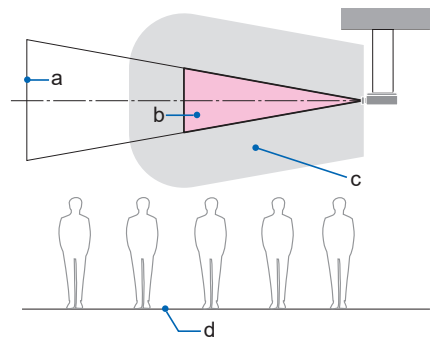

CAUTION

- If it is expected that spectators will intrude into the hazard zone when installed on the ceiling, it is necessary to prevent spectators from entering that area.

Safety operation guideline

③ Example of downward projection installed on the ceiling

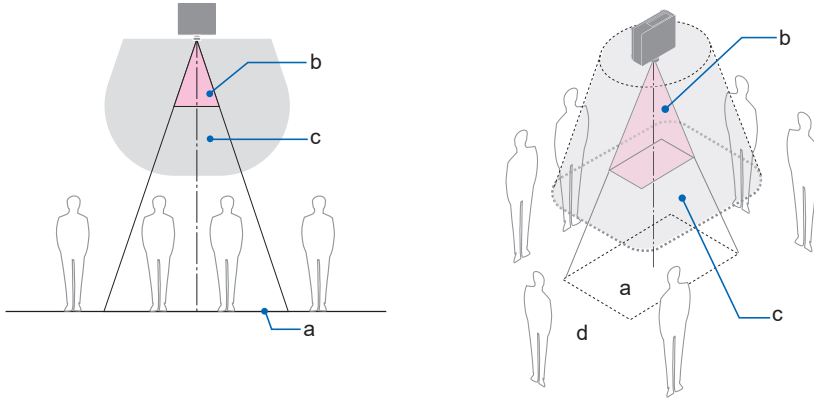

a: Screen / b: Hazard zone / c: Precautionary zone / d: floor



CAUTION

- If the precautionary zone between the floor and the hazard zone cannot be secured, it is necessary to prevent spectators from entering the area around the screen as shown in the figure on the right.



Note □

- If using the lens shift, please consider the shift of projected image according to the volume of lens shift. Installation example considering the precautionary zone.

Safety operation guideline

Combining lens units and risk groups

Lens model name	Throw ratio	Risk group
AH-AV22060	0.53-0.65	RG3
AH-AV22070	0.65-0.87	RG3
AH-AV21020	0.86-1.25	RG3
AH-AV21030	1.24~2.01	RG3
AH-AV24010	1.98-3.95	RG3
AH-AV23030	3.95-7.50	RG3

Radiation Zone

The below table describes the radiation zone of emitted light by the projector

Horizontal

Lens		Radiation zone(degree)		
		Far Right	Center	Far Left
		H Right	H Center	H Left
AH-AV22060	Wide	52.86	43.32	52.86
	Tele	47.02	37.47	47.02
AH-AV22070	Wide	47.33	37.77	47.33
	Tele	38.94	29.99	38.94
AH-AV21020	Wide	41.24	30.30	41.24
	Tele	30.85	21.71	30.85
AH-AV21030	Wide	31.16	21.96	31.16
	Tele	20.46	13.97	20.46
AH-AV24010	Wide	20.80	14.21	20.80
	Tele	10.77	7.26	10.77
AH-AV23030	Wide	10.99	7.38	10.99
	Tele	5.79	3.87	5.79

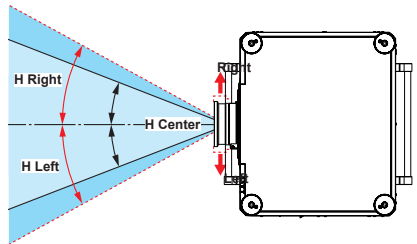

Vertical

Lens		Radiation zone(degree)		
		Top	Center	Bottom
		V Up	V Center	V Down
AH-AV22060	Wide	49.69	30.52	49.69
	Tele	43.78	25.60	43.78
AH-AV22070	Wide	45.48	25.84	45.48
	Tele	37.14	19.84	37.14
AH-AV21020	Wide	40.03	20.06	40.03
	Tele	29.78	13.97	29.78
AH-AV21030	Wide	30.09	14.14	30.09
	Tele	19.68	8.84	19.68
AH-AV24010	Wide	20.00	9.00	20.00
	Tele	10.33	4.53	10.33
AH-AV23030	Wide	10.54	4.63	10.54
	Tele	5.55	2.42	5.55

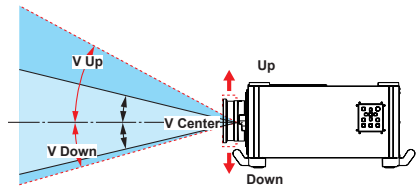

Safety operation guideline

Safety Labels

- ① . Do not look directly into the projector lens. The strong light from the projector while it is working can damage your eyes.
- ② . Do not place anything in front of the lens while the projector is running. Things placed in front of the camera can overheat, burn, or catch fire. If you want to temporarily stop projecting images, use the Blank key on your remote control.
- ③ . Class 1 laser product warning.
- ④ . Do not remove the screws. Do not block or cover vents.
- ⑤ . Photobiological Level RG3 warning label.

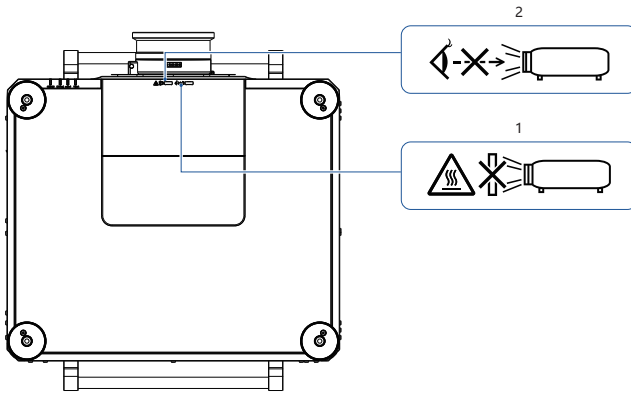

⑤

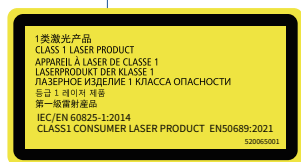
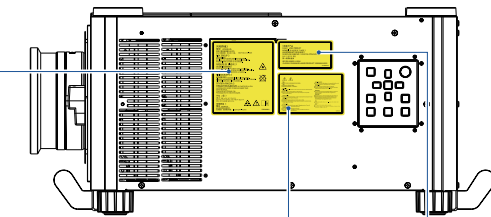

4

Safety operation guideline

Air ventilation

Openings in the casing are designed for ventilation and overheating prevention. DO NOT block or cover these openings to keep your projector in normal operation and from overheating.

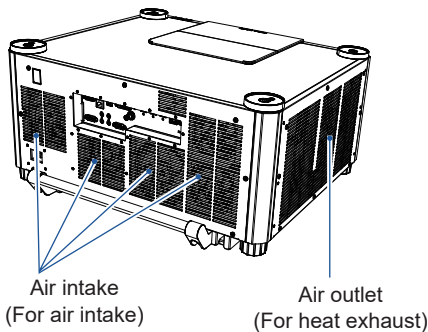
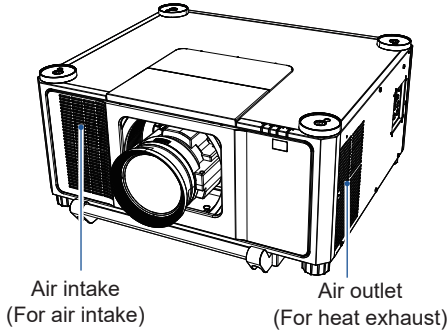

Note:

Heat exhaust at the air outlet. Keep the following in mind when using or installing your projector:

- DO NOT place flammable materials or sprayers near your projector.
- Keep the air outlet one meter away from other objects.
- DO NOT touch the area close to the air outlet especially the metal components, e.g. screws. This area and parts will get very hot once your projector starts operating.
- DO NOT place any object atop your projector. They may not only be damaged but also lead to fire after being overheated.

Cooling fans are designed for cooling your projector. Fan speed is auto adjusted subject to internal temperature of your projector.

Place your projector correctly

Use your projector at specified location in correct way. Invalid projector location may shorten light source's life-cycle or even lead to severe incidents or fire.

360° projection

Our projector support 360° projection.

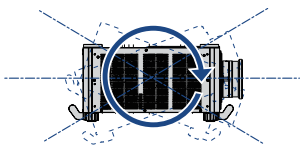

Vertical 360°

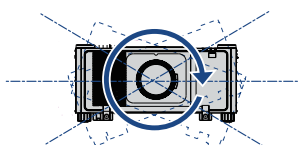

Horizontal 360°



Vertical & Horizontal 360°

Safety operation guideline



Note:

Precautions on ceiling mount bracket installation:

- Get qualified technician to install the ceiling mount bracket.
- Warranty of your projector does not cover hazards and damage caused by using ceiling mount brackets provided by unauthorized dealers.
- Remove the ceiling mount bracket when it is not in use.
- Apply torque driver instead of power driver or impact driver in your projector.

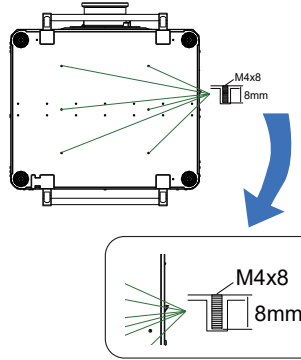

Moving your projector

When moving your projector close its adjustment legs as they may damage the lens and casing. Keep your projector in suitable box when it is not to be used for a long time.



Note:

Precautions on moving or shipping your projector:

- DO NOT drop or impact your projector as it may get damaged or failed in operation.
- Please employ proper container for movement.
- Prohibit express or other shipping service provider personnel from shipping your projector with improper boxes. Your projector may become damaged. Please consult your dealers for shipping your projector by express or other shipping service providers.
- Place your projector in box only after it has been fully cooled down.

Compliance

FCC Caution

Declaration of Conformity

This device complies with Part 15 of the FCC Rules.
Operation is subject to the following two conditions:

(1) This device may not cause harmful interference, and (2) this device must accept any interference received, including interference that may cause undesired operation.

To assure continued compliance, follow the attached installation instructions and do not make any unauthorized modifications.

CAUTION:

This equipment has been tested and found to comply with the limits for a Class A digital device, pursuant to part 15 of the FCC Rules. These limits are designed to provide reasonable protection against harmful interference when the equipment is operated in a commercial environment. This equipment generates, uses, and can radiate radio frequency energy and, if not installed and used in accordance with the instruction manual, may cause harmful interference to radio communications. Operation of this equipment in a residential area is likely to cause harmful interference in which case the user will be required to correct the interference at his own expense.

Model Number : V2200 series

Trade Name : EIKI

Responsible party : EIKI International, Inc.

Address : 30251 Esperanza Rancho Santa Margarita CA 92688-2132

Telephone No. : 800-242-3454 (949-457-0200)

AC Power Cord Requirement

The AC Power Cord supplied with this projector meets the requirement for use in the country you purchased it.

AC Power Cord for the United States and Canada:

AC Power Cord used in the United States and Canada is listed by the Underwriters Laboratories (UL) and certified by the Canadian Standard Association (CSA).

AC Power Cord has a grounding-type AC line plug. This is a safety feature to be sure that the plug will fit into the power outlet. Do not try to defeat this safety feature. Should you be unable to insert the plug into the outlet, contact your electrician.

AC Power Cord for the United Kingdom:

This cord is already fitted with a moulded plug incorporating a fuse, the value of which is indicated on the pin face of the plug. Should the fuse need to be replaced, an ASTA approved BS 1362 fuse must be used of the same rating, marked thus . If the fuse cover is detachable, never use the plug with the cover omitted. If a replacement fuse cover is required, ensure it is of the same colour as that visible on the pin face of the plug (i.e. red or orange). Fuse covers are available from the Parts Department indicated in your User Instructions.

If the plug supplied is not suitable for your socket outlet, it should be cut off and destroyed.

The end of the flexible cord should be suitably prepared and the correct plug fitted.

WARNING : A PLUG WITH BARED FLEXIBLE CORD IS HAZARDOUS IF ENGAGED IN A LIVE SOCKET OUTLET.

The Wires in this mains lead are coloured in accordance with the following code:

Green-and-yellow	Earth
Blue	Neutral
Brown	Live

As the colours of the wires in the mains lead of this apparatus may not correspond with the coloured markings identifying the terminals in your plug proceed as follows:

The wire which is coloured green-and-yellow must be connected to the terminal in the plug which is marked by the letter E or by the safety earth symbol  or coloured green or green-and-yellow.

The wire which is coloured blue must be connected to the terminal which is marked with the letter N or coloured black.

The wire which is coloured brown must be connected to the terminal which is marked with the letter L or coloured red.

WARNING: THIS APPARATUS MUST BE EARTHED.

THE SOCKET-OUTLET SHOULD BE INSTALLED NEAR THE EQUIPMENT AND EASILY ACCESSIBLE.

Accessories

Quick Start Guide

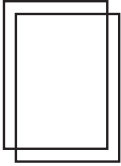

AC Power Cord

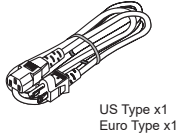

HDMI Cable

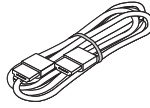

Remote Control



Safety Information

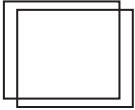

Warranty Sheet
(For US only)

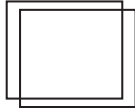

Power Cord Lock

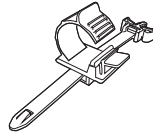

Dust proof Cover for Lens
(Attached to the projector)

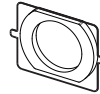

Overview

This chapter presents names and functions of individual component.

Name and function of your projector

Front/Top

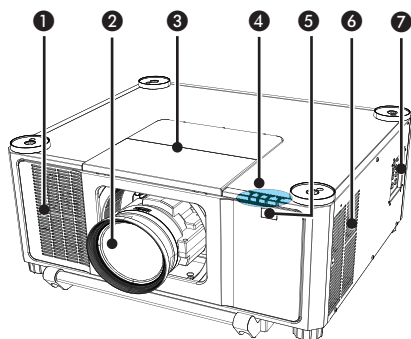

- ① Air intake
- ② Projection lens
- ③ Lens cover
- ④ LED indicator
 - Power indicator
 - Status indicator
 - Light indicator
 - Shutter indicator
- ⑤ IR remote receiver (Front)
- ⑥ Air outlet
- ⑦ Control panel

Rear/Side

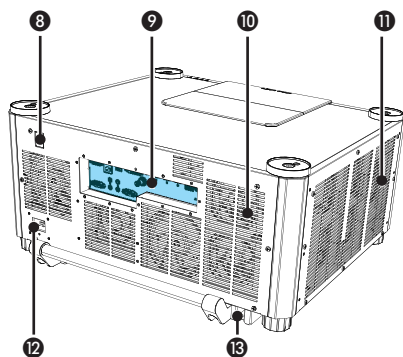

- ⑧ IR remote receiver (Rear)
- ⑨ Input / Output terminal
- ⑩ Air intake
- ⑪ Air outlet
- ⑫ AC power cord connector
- ⑬ Anti-theft chain

Bottom

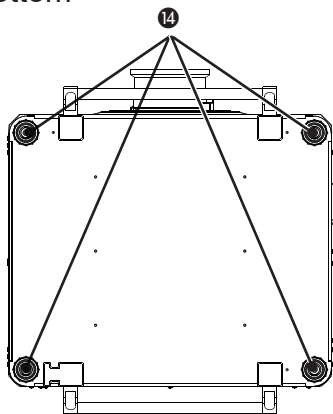

- ⑭ Adjustable feet

Name and function of your projector

Terminal

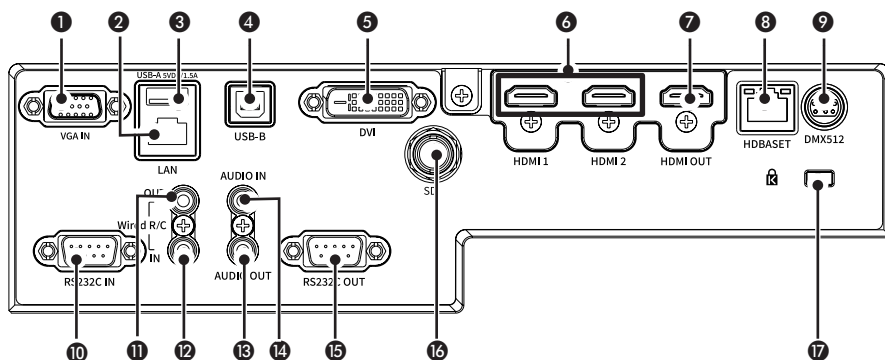

- 1** **VGA IN**
Connect output signal from computer to this terminal.
- 2** **LAN**
Connect network cable to this port for controlling and operating your projector via network
- 3** **USB-A IN**
When using the Memory Viewer function, insert the USB memory directly to this terminal.
- 4** **USB-B IN**
The terminal is to use the USB display function, when connected the projector to computer with USB cable
- 5** **DVI-D IN**
Connect DVI output signal to this terminal.
- 6** **HDMI 1 / HDMI 2 IN**
Connect HDMI digital output signals to this terminal.
- 7** **HDMI OUT**
Transmit signals from **6** to other displays
- 8** **HDBaseT**
Connect to HDBaseT source via network cable.
- 9** **DMX512**
Through the DMX 512 connection cable, connect this terminal to realize the multiple projectors control by the DMX512 device.
- 10** **RS232C IN**
Connect serial cable to this terminal when using RS232 device to control or operate your projector.
- 11** **Wired R/C OUT**
Transmit wired remote controller signals of **12** to another projector when a wired remote controller is used.
- 12** **Wired R/C IN**
Connect wired remote controller to this terminal. Connection of a wired remote controller will disable the wireless remote control function
- 13** **AUDIO OUT**
Output audio signals to amplifier or other audio equipment.
- 14** **AUDIO IN**
"Line out" to "AUDIO OUT" terminal from input audio signals. (Speakers are not equipped.)
- 15** **RS232C OUT**
Connect serial cable to this terminal when using RS232 device to control or operate your projector.
- 16** **SDI OUT**
Connect SDI output signal to this terminal
- 17** **Kensington Security Slot**
This slot is for a Kensington lock used to deter theft of the projector.
* Kensington is a registered trademark of ACCO Brands Corporation

Name and function of your projector

Control Panel

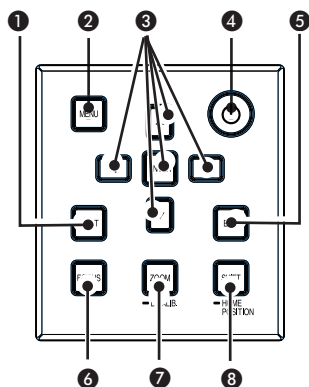

- 1 INPUT**
Open / Close the Input source menu
- 2 MENU**
Open or close the On Screen Display menu.
- 3** ◀ ▶ ▶ ▶
Select or setting the value at the OSD
ENTER
 - Get into the submenu of OSD
 - Confirm the selection of OSD
- 4 POWER**
Power On / Power off the projector
- 5 EXIT**
 - Stop the current function
 - Return the previous menu of OSD
- 6 FOCUS**
Arrange the focus while projected image
- 7 ZOOM / L-CALIB**
 - Adjust the image size
 - Launch the lens calibration function by press the ENTER button at the same time.
- 8 SHIFT / HOME POSITION**
 - Adjust the image position
 - Move the Lens to the center position by press the ENTER button at the same time.

Name and function of your projector

Remote controller

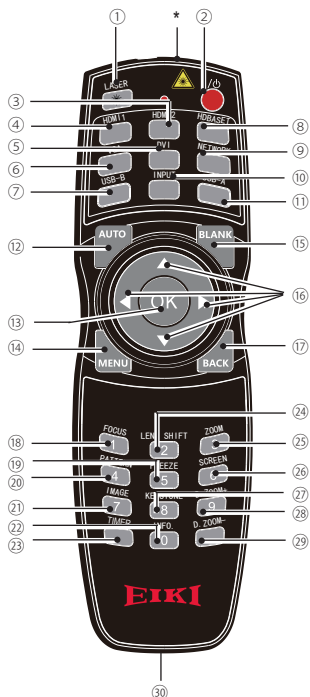

* Laser Transmitting Window:

Laser beam will emit from this window while pressing LASER button during the projection to use the remote controller as a laser pointer.

Do not stare directly at the laser transmitting window or aim the window at human body, to avoid any physical injury.

- ① **LASER**
Press the LASER button during presentation to use the remote controller as laser pointer
- ② **POWER**
Power on or off your projector.
- ③ **HDMI 2**
Select HDMI2 input source
- ④ **HDMI 1**
Select HDMI1 input source
- ⑤ **DVI**
Select DVI input source
- ⑥ **VGA**
Select VGA input source
- ⑦ **USB-B**
Select USB-B input source for USB Display
- ⑧ **HDBaseT**
Select HDBaseT input source
- ⑨ **NETWORK**
Select LAN input source for Network Display
- ⑩ **INPUT**
Open or close the INPUT menu
- ⑪ **USB-A**
Select USB-A input source for Memory Viewer
- ⑫ **AUTO**
Enter auto adjustment mode
- ⑬ **OK**
Enter the OSD menu or select options in it
- ⑭ **MENU**
Open or close the OSD menu
- ⑮ **BLANK**
Dark out screen images temporarily
- ⑯ **▲▼◀▶ (Arrow)**
– Select items or adjust values in the OSD menu
– Select display area in digital zoom+ mode
- ⑰ **BACK**
Return to the previous menu while using OSD
- ⑱ **FOCUS**
Enter the focus adjustment mode
- ⑲ **FREEZE**
Freeze projected images
- ⑳ **PATTERN**
Select built-in test pattern of your projector
- ㉑ **IMAGE**
Select image mode
- ㉒ **INFO.**
Display current status information of your projector
- ㉓ **TIMER**
Enable the timer function
- ㉔ **LENS SHIFT**
Enter the lens moving mode

Name and function of your projector

- ②5 ZOOM
Enter the zooming mode
- ②6 SCREEN
Select screen size
- ②7 KEYSTONE
Keystone calibration
- ②8 D.ZOOM+
Digital zoom in projected image
- ②9 D.ZOOM-
Digital zoom out projected image
- ③0 Wired remote controller output terminal
Connect cable of wired remote controller to this port while operating the projector by wired remote control

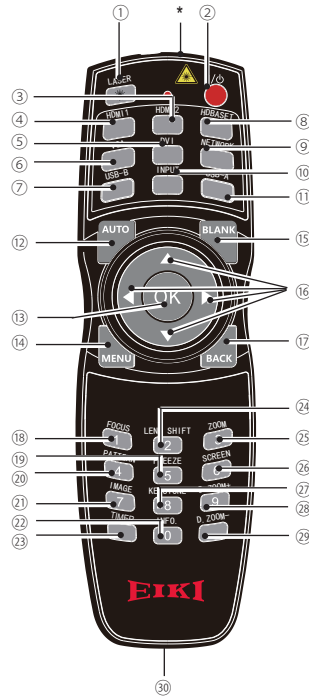

Remote controller operation range

Point your remote controller to the IR receiver of your projector

Maximum operation range of your remote controller is an area of radius 7 meters and arc 60° in front of and behind your projector

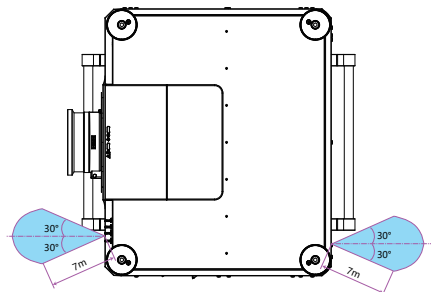

Name and function of your projector

Install battery of remote controller

- 1 Open the battery cover.

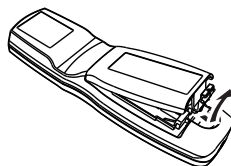

- 2 Insert a new battery in it.
Two AA (LR6) batteries
Place your batteries with its anode and cathode (+ and -) in correct direction. Keep both poles in good connection to the contacts within the compartment.

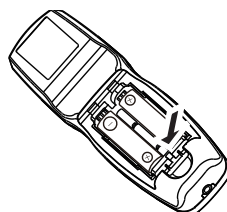

- 3 Put the cover back.

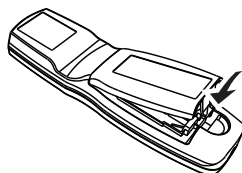

Please follow the following rules for safety operation:



- Use two of AA or LR6 alkaline batteries.
- Replace both batteries at the same time.
- Do not mix new and old batteries as one pair.
- Keep your remote controller away from water or other liquids.
- Do not expose your remote controller to environments with high humidity or temperature.
- Do not drop your remote controller.
- In case of any battery solution leaking in the compartment, clear it thoroughly before placing new batteries in it.
- Using battery of other types than what specified on this manual may lead to risks of explosion.
- Please dispose your old battery by following instructions given in tag of the battery or local regulations.

Installation

This chapter introduces the information of install.

Installation

Lens installation

Please follow steps given below to install lens after its replacement or when optional ones are employed. Please consult your dealers for details on optional lenses.

Installing lens

- 1 Remove the Dust Proof Cover as the first time installation.

Remove the Lens cap at the lens

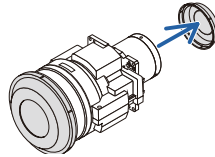
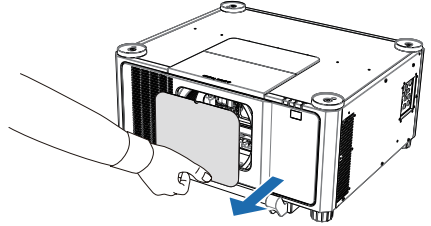

- 2 Push and pull the Lens cover

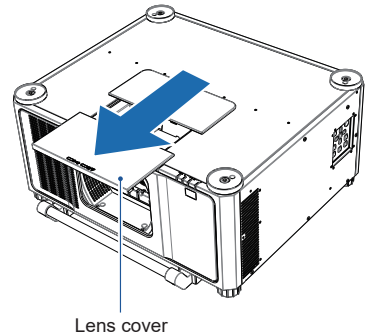

- 3 Ensure the Lens lock lever has position at UNLOCK.

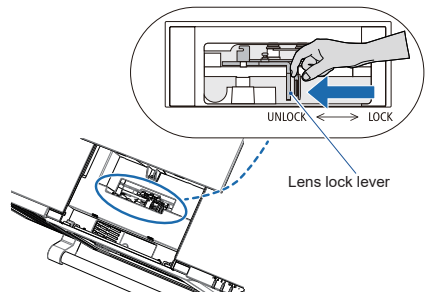

Installation

- 4 Ensure the lens's model label is face up and then put the lens into the projector as far back as possible.

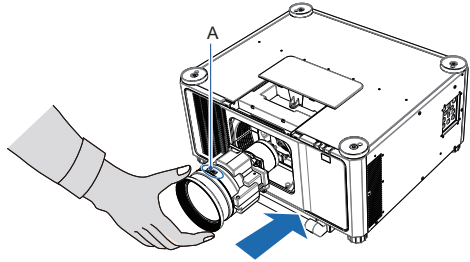

- 5 Hold the lens on hand and use the other hand to move the Lens lock lever to the LOCK position.

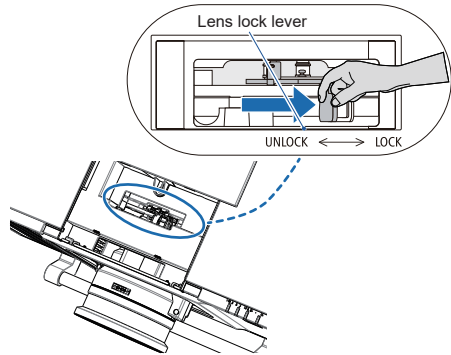

- 6 Put the lens cover back.

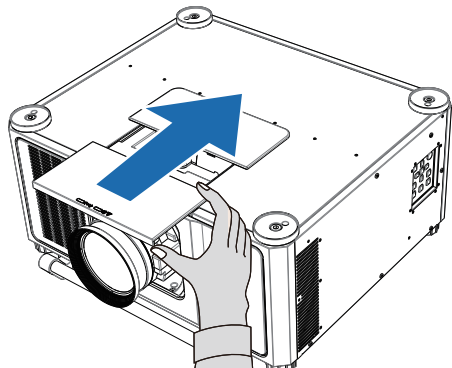

Installation

Remove the lens

- 1 Push and pull the lens cover.
- 2 Switch the Lens lock lever to the UN-LOCK position.
- 3 Hold and remove the lens from projector.
- 4 Put the lens cap back to avoid the damage.
- 5 Put the Dust Proof Cover back to the projector to avoid the dust.

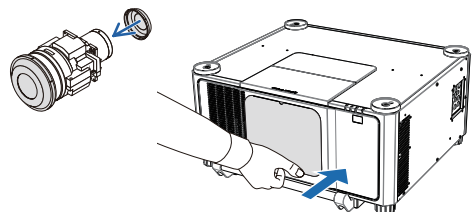
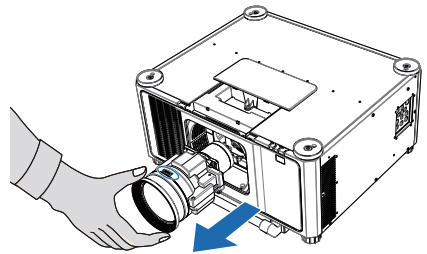
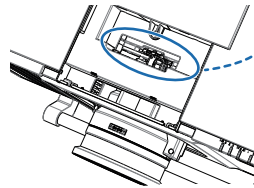
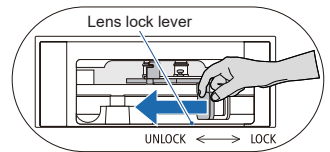
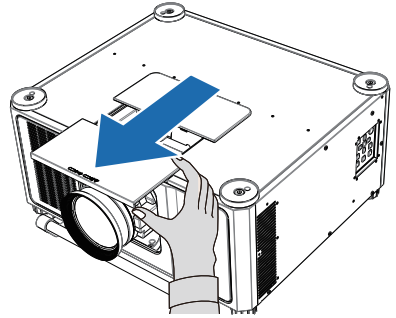

Installation



Note

- Do not touch or remove any other component except the lens and parts related to it. Otherwise, you may experience product failure, electric shock, fire, or other incidents.
- Make sure model of the lens is compatible with your projector before installing it.
- For details of lens and the installation, please contact your dealers.
- When replacing the optional lenses, it must be done by qualified personnel. Pay attention to mechanical hazards and high temperature injuries during replacement.
- Be careful in removing the lens. Do not drop it.
- For safety reasons, please ensure power off while replacing the optional lens to avoid electric shock fire and other accidents.
- When replacing the optional lens, just for safety reasons, please be sure to cut off power to avoid electric shock fire and other safety accidents.
- The projector and lenses are made of precision parts. Do not subject them to shock or excessive forces.
- Remove the separately sold lens when moving the projector. If not, the lens could be subject to shock while the projector is being moved, damaging the lens and the lens shift mechanism.
- If the projector must be moved with the lens unit attached, such as when it is installed in a high or specific location, use the screws included with the lens unit to secure it to the projector. Do not hold the lens when moving the projector.
- When dismantling the lens from the projector, return the lens position to the home position before turning off the power. Failure to do so may prevent the lens from being mounted or dismantled because of narrow space between the projector and the lens.
- Never touch the lens surface while the projector is operating.
- Be very careful not to let dirt, grease, etc., on the lens surface and not to scratch the lens surface.
- Perform these operations on a flat surface over a piece of cloth, etc., to prevent the lens from getting scratched.
- When leaving the lens off the projector for long periods of time, mount the dust cap on the projector to prevent dust or dirt from getting inside.

Installation

Set up your projector

- Ambient brightness may affect your projection image quality. For the optimal image effect, it is recommended to control brightness in your environment.
- Values shown in figure below are approximates only. They may differ from the actual ones.

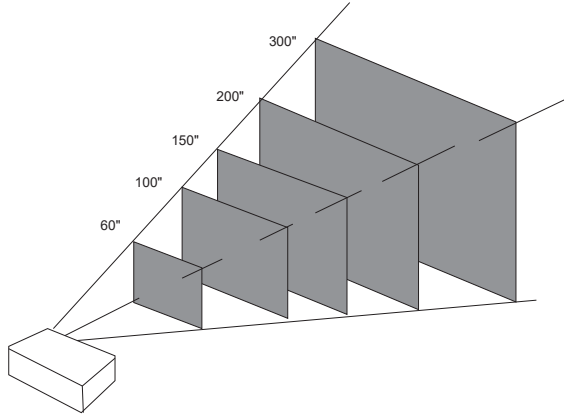

16:10

Unit:m

Lens Model No.		Screen Size (Diagonal)											
		60 inch		100 inch		150 inch		200 inch		300 inch		500 inch	
		Width	Hight	Width	Hight	Width	Hight	Width	Hight	Width	Hight	Width	Hight
		1.29	0.81	2.15	1.35	3.23	2.02	4.31	2.69	6.46	4.04	10.77	6.73
AH-AV21030	Wide	1.57	2.67	4.05	5.43	8.18	13.69						
	Tele	2.57	4.33	6.53	8.73	13.14	21.95						
AH-AV22060	Wide	0.66	1.14	1.74	2.35	3.55	5.96						
	Tele	0.82	1.41	2.14	2.87	4.33	7.25						
AH-AV22070	Wide	0.81	1.39	2.11	2.84	4.28	7.17						
	Tele	1.10	1.87	2.82	3.78	5.70	9.53						
AH-AV21020	Wide	1.09	1.84	2.79	3.73	5.62	9.40						
	Tele	1.60	2.71	4.08	5.46	8.21	13.72						
AH-AV24010	Wide	2.50	4.25	6.44	8.63	13.00	21.75						
	Tele	5.05	8.50	12.80	17.10	25.73	42.96						

Installation

Lens shift adjustment

The electric lens shift function may adjust your lens in all four directions. This function enables easy image position adjustment.

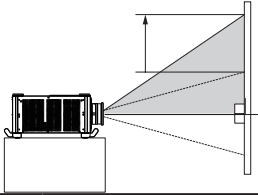
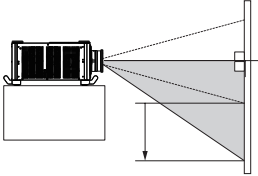
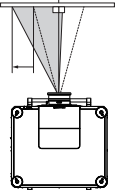
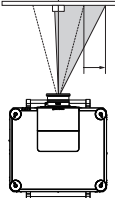
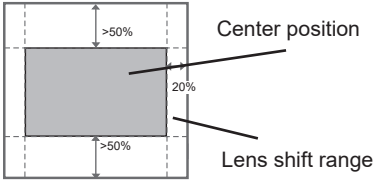
<p>The projection location of your image may be moved upward a distance up to 50% of the length of the image.</p>	<p>Move lens to it top position</p> 
<p>The projection location of your image may be moved downward a distance up to 50% of the length of the image.</p>	<p>Move lens to it bottom position</p> 
<p>The projection location of your image may be moved leftward a distance up to 20% (with AH-EC22030, AHEC21020, AH-EC24010 lens) / 30% (with AH-EC21030, AH-EC23030 lens) of the width of the image.</p>	<p>Move lens to it leftmost position</p> 
<p>The projection location of your image may be moved rightward a distance up to 20% (with AH-EC22030, AHEC21020, AH-EC24010 lens) / 30% (with AH-EC21030, AH-EC23030 lens) of the width of the image.</p>	<p>Move lens to it rightmost position</p> 
<p>Scope of lens shift adjustment</p>	

*When the setting of LENS SHIFT as the maximum position, the corner of projection image might be darker.

Installation

Adjustment pad

You may use the adjustment leg to raise your projector up to 10 mm.

Turn the pad to tilt your projector to required height.

To raise your projector, turn both pads clockwise.

To lower down your projector or close the pad, turn both pads counterclockwise.

You may use the auto setup function to adjust your projector's keystone distortion automatically or do this with the remote controller or OSD menu manually.

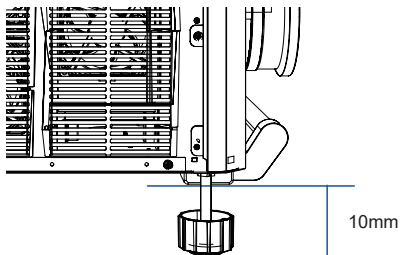
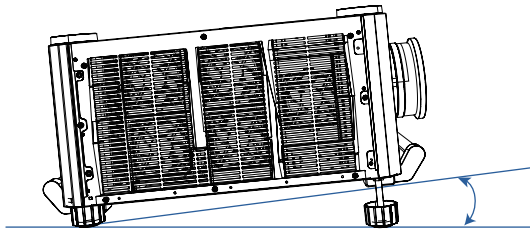
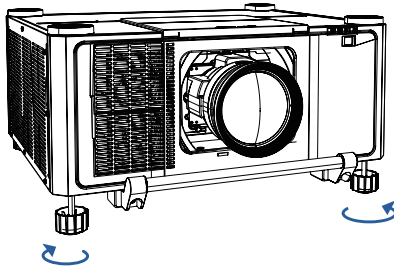

Connection to Power

Connect the AC power cord

Standard voltage employed by your projector is AC 100-240V. It adapts to different input voltage automatically. Your projector employs 2-phase power cord with neutral ground cable.

Do not use any other type of power cords or you may face the risks of electric shock. In case you have any doubt on type of power cord you are using, please call authorized dealer or service center for help. Before powering on your projector, get all external equipment connected in advance.



Note:

Keep your AC power socket close to your projector for easy plugging and unplugging.

✓ Note:

For safety reasons, unplug the AC power cord when your projector is not in use. Your projector will consume a small amount of power when it is connected to AC grid power and in standby mode.

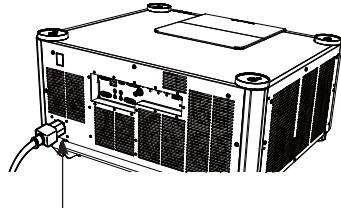

Connect included AC power cord to your projector.

Precautions on power cord

Your AC power cord should meet regulations of the country/district where your projector is used.

Please make sure the type of the power plug is compliant with those given in figure below.

Make sure you are using a valid AC power cord.

In case the included AC power cord does not comply with the AC power socket in your location, call your dealer for replacement.

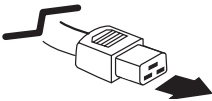
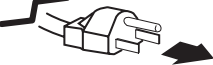
The projector side	Connect to the AC power socket
 <p data-bbox="132 1088 472 1129">Connect to power cord connector of your projector</p>	<p data-bbox="741 960 882 986">Grounding end</p>  <p data-bbox="624 1088 898 1114">Connect to AC power socket</p>

✓ Note:

- Use of invalid power cord may hamper product performance or even lead to electric shock, fire, and other incidents. Please use power cord compliant with the included one to ensure product performance and operation safety.
- The frequently used cables are: AC power cord, VGA cable, audio cable, video cable, and RS232 control cable.

Connection to equipment

Connection to computer

Cables used for connection:

- VGA cable
- USB cable*
- DVI cable*
- HDMI cable*
- USB device*
- Serial cable*

(*Cables are not supplied with the projector)

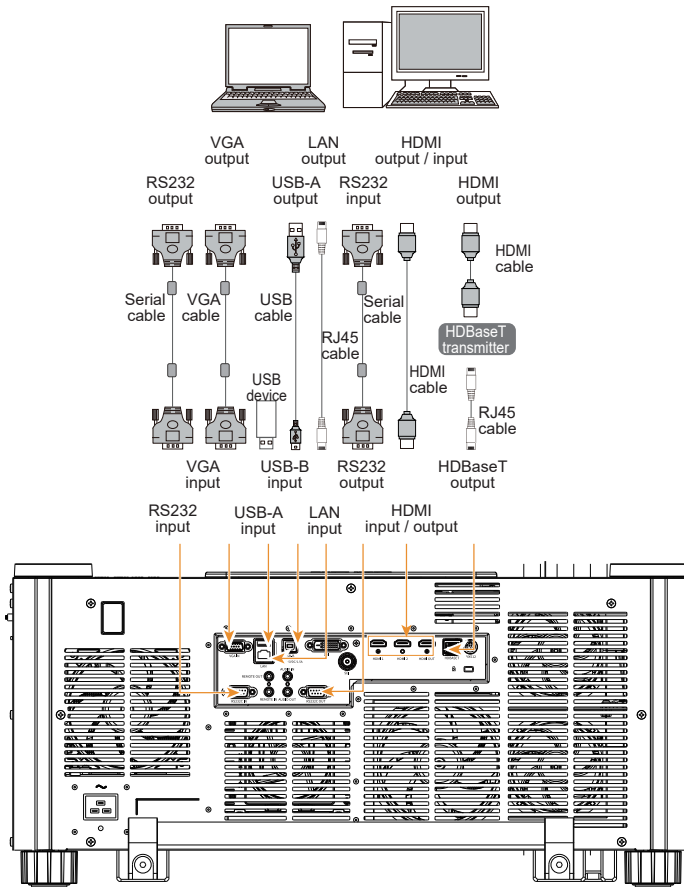

Unplug power cords of the projector and all external equipment before connecting any cable to them.

Connection to equipment

Connection to video and audio equipment

Cables used for connection:

- DMX512 cable*
- RJ45 cable*
- DVI cable*
- Audio cable*
- HDMI cable*

(*Cables are not supplied with the projector)

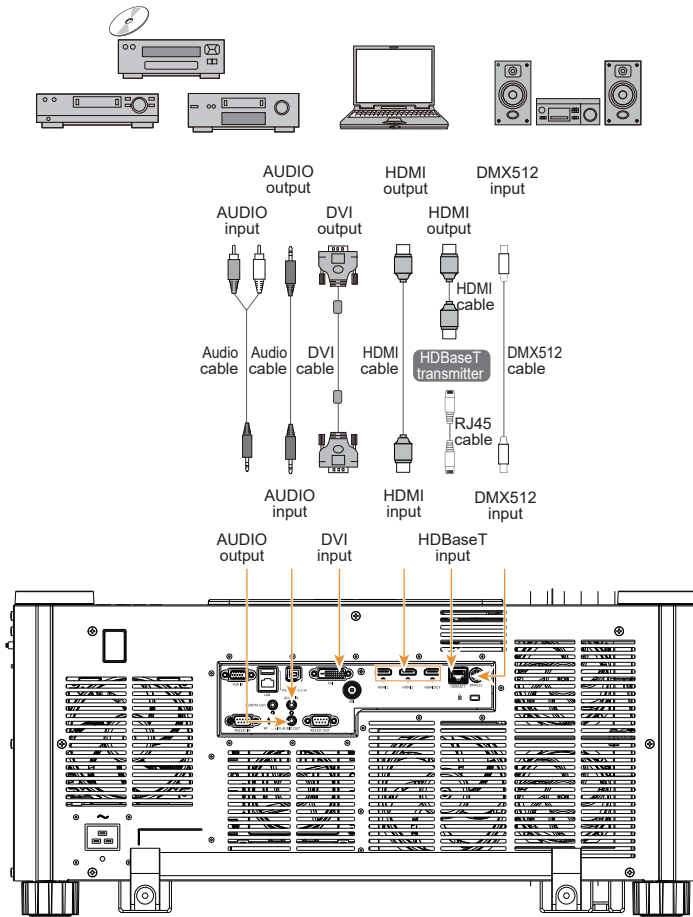

Unplug power cords of the projector and all external equipment before connecting any cable to them.

Operation

This chapter introduces you to basic operation of your projector.

Basic operation

Power on your projector

1. Connect all external equipment to your projector (e.g. computer or camera) before powering it on.
2. Connect AC power cord of your projector to an AC power socket. The Power indicator turns on in red.
3. Press the Power button on the rear control panel or the remote controller.
The Power indicator lights in green and the cooling fan starts running.
4. If your projector is setting as password protected, the password dialog box displays. Enter your password as instructed below.



✓ Note:

- In case the "Logo Select" option is set to OFF, then no welcome image will display in screen.

Enter password (PIN)

Press OK button to insert the PIN code. Press ◀▶ button to select number, then press OK button to set it and the cursor would move to next field automatically. The number you set is displayed as "*" . Repeat to fill in a 3-digit number. If any mistake, press MENU button to reset.

After fill in the PIN code, the cursor would move to the "Set" selection. Press the OK button and now you are ready to use your projector. Or press ▶ button select "Cancel" to give up the setting.

If the password is invalid, the password displayed as "***" in red and reset within one second automatically. Please try again with a valid one.

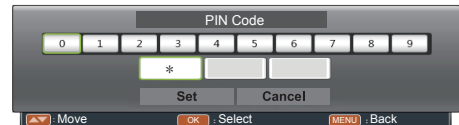

What is a password (PIN)?

A password (PIN) is an ID code for identifying people who know about it to operate your projector. A password (PIN) setting may help preventing your projector from unauthorized use.

Your password (PIN) code is a 3-digit number. To find out more about protecting your projector with a password (PIN), please refer to the PIN Code Lock function in the Securit menu on Page 64 for details.

Precautions on password (PIN) operation

You cannot operate a password (PIN) protected projector without correct password (PIN). Please set up a new password (PIN) and keep your operation manual in safe place. In case the password (PIN) is lost or forgotten, contact your dealer or service center.

Basic operation

Power off your projector

1. Press the Power button at the control panel or the remote controller, then “Power off?” message displays.
2. Press the Power button again within 4 seconds after the “Power off?” message prompted to you. The POWER indicator flashes red while the cooling fan continues running. Unplug the power cord after the fan stops running. Failure to do so may shorten life cycle of your projector or lead to power on failures or operation abnormalities.
3. The POWER indicator stops flashing once the projector has been cooled down to ready for power on again.

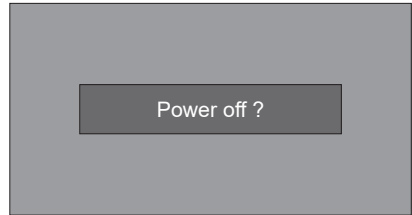

“Power off ?” disappears after 4 seconds.



To maintain the life cycle of the laser light source, power off your projector after it has been turned on for at least five minutes.





Do not use your projector without stop. As it may hurt the life cycle of your lamp. Power off your projector at least once every 24 hours and have it idle for an hour.

✓ Note:

- If the “Direct power on” function is set to “On”, your projector will power on once it is connected to an AC power socket. (Refer to page 56)
- Speed of the cooling fan varies with internal temperature of your projector.
- Do not place your projector in any box before it is fully cooled down.
- In case the POWER indicator flashes or turns red, refer to the “Light indicator status” for instructions. (Refer to page 88)
- The POWER indicator flashes when the lamp is cooling down. Do not power on your projector at this time. Power on your projector only after the POWER indicator turns steady red.
- Unplug the power cord after your projector has been turned off. The fan stops running.
- The POWER indicator turns red when your projector is ready for power on again. It takes less time to restart your projector after it was powered off in the standard power off procedure than that of the non-standard one.



Basic operation

Focus function

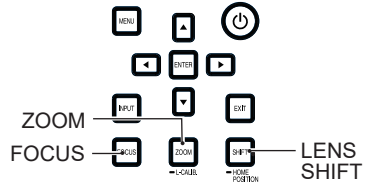
1. Press the  FOCUS button on the control panel or "FOCUS" button on the remote controller to adjust the projection image with Focus function.
2. Press   button to adjust the focus for center area of the image .
Press   button to adjust the focus for around area of the image .





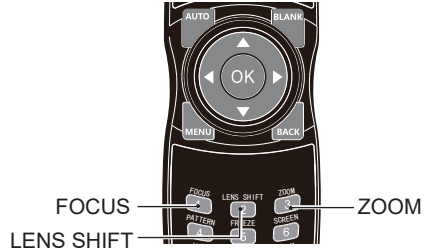

Zoom function

1. Press the  ZOOM button on the control panel or "ZOOM" button on the remote controller to adjust the projection image with zoom function.
2. Press   button to zoom in and out.



Lens Shift function

1. Press the  SHIFT button on the control panel or "LENS SHIFT" button on the remote controller to adjust the position of the projection image.
2. Movement of the lens is shown on the screen. Press     button to move the screen to required location without any image distortion.

Focus



Zoom



Lens Shift

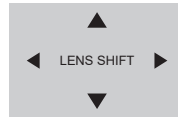

Basic operation

Keystone adjustment

You may adjust keystone distortion of image with the keystone adjustment.

Follow steps below to adjust keystone distortion of projected image manually.

Press the KEYSTONE button on your remote controller.

The Keystone selection menu show up, press ▲▼ button to select the adjustment.

The keystone adjustment dialog box displays, press ▲▼◀▶ button to adjust keystone distortion.

You may save your settings for keystone adjustment.

H/V Keystone

Adjust the projected image when the projector is on the horizontal or vertical keystone distortion.

6-Corner correction

Adjust the projected image when the projector is keystone distortion of six corners

Curved correction

Adjust the projected image when the projector linearity is uneven or the projected images bent vertically and horizontally.

Reset value

The correction values will be restored to the factory defaults.



Keystone adjustment

H/V keystone

6-Corner correction

Curved correction

Reset value

✓ Note:

- The adjustable range is subject to input signal.
- For details please refer to page 61

Basic operation

How to use the OSD

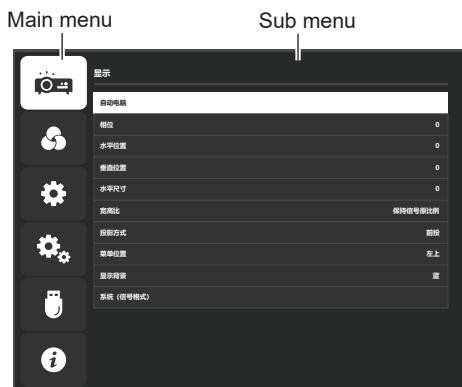

Menu operation

1. Press the MENU button on the control panel or the MENU button on the remote controller and the OSD displays.
2. Press button to act on or select one main menu item. Press button or ENTER/OK button to enter a submenu.
3. Press button to select required submenu, then press ENTER/OK button or button to set up or enter an option.
4. Press button to select settings or navigate options, then press ENTER/OK button to act on the item.
5. Press button or EXIT button to return to mainmenu.
6. Press the MENU button on remote controller or EXIT button on the control panel to exit the OSD.

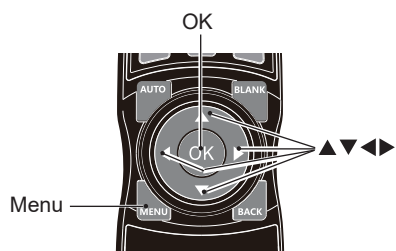
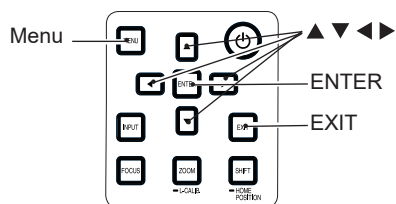

Basic operation

Menu item overview

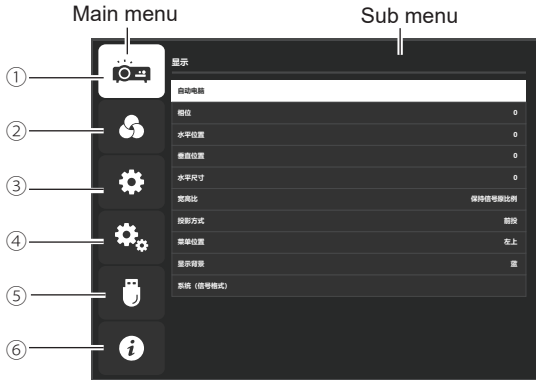

- ① Display
Select Auto PC Adj., Fine sync., H Position, V Position, H size, Aspect, Project way, Menu position, Background display, System to align each parameter with input source.
- ② Color adjust
The color adjust options for different input source:
Image mode, Contrast, Brightness, Color temp., Red, Green, Blue, Sharpness, Gamma, Uniformity and Advanced color adj..
- ③ Setting
Used to set the projector's operating configurations.
- ④ Expand
Setting the Language, Auto setup, Keystone, Logo, Security, Power management, Lens adjust., Test pattern, Network and Factory default function as you need.
- ⑤ Memory Viewer
Setting the display method of Memory Viewer page as Set slide, Slide transition effect, Sort order, Best fit, Rotate, Repeat and Apply.
- ⑥ Info.
Display the information about projector.

Basic operation

Remote controller operation

Use your remote controller for common operations.

Auto setup function (AUTO)

Press the AUTO button to launch the Auto PC adjustment function with the Input source as VGA

Image mode selection (IMAGE)

Press the IMAGE button to select required image mode.

Timer (TIMER)

Press the TIMER button, a timer animation (00:00) displays and starts timing in format of (00:00-59:59).

Press the TIMER button again to stop timing. Press the TIMER button again to disable the timing function.



Timer display

Blank (BLANK)

Press the BLANK button, a blank screen displays to replace existing image. Press the BLANK button or any other button to restore the image.

Press the BLANK to toggle switch your screen as shown below:

BLANK → Normal → BLANK → Normal →

Screen size selection (SCREEN)

Press the SCREEN button to select required screen size.

Digital Zoom (D.ZOOM+/-)

Press the D.ZOOM+/- button to enter the Digital Zoom mode.

*Only for input as VGA and the screen size setting as Normal or Wide.

Freeze (FREEZE)

Press the FREEZE button to freeze image on the screen. Press the FREEZE button or any button to disable the freeze function.

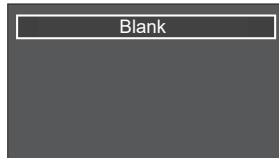
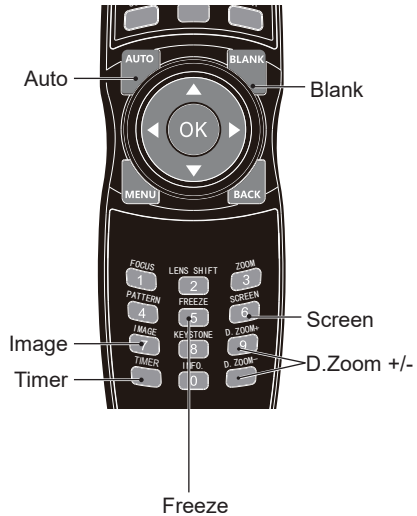

The "Blank" notification will disappear in 4 seconds.

Input selection

Input select

Direct Operation

Press HDMI 1, VGA, USB-B, HDMI 2, DVI, HDBASET, NETWORK or USB-A on the remote control as input source.

Menu operation

1 Press INPUT button on the remote control or control panel to display the input select menu.

2 Press ▲▼ button to select VGA, HDMI 1, HDMI 2, HDBaseT, SDI, DVI, Memory Viewer, Network or USB Display, then press the OK button.

VGA

When input source is from computer connected to VGA terminal with VGA cable, please select "VGA".

HDMI 1

When input source is from equipment connected to HDMI terminal with HDMI cable, please select "HDMI 1".

HDMI 2

When input source is from equipment connected to HDMI terminal with HDMI cable, please select "HDMI 2".

HDBase T

When input source is from equipment connected to HDBaseT terminal with RJ45 cable, please select "HDBaseT".

*This function is not available for EK-512X

DVI

Select it when the video input signal is connected to DVI IN terminal.

Memory Viewer

When input source is from device connected to USB-A terminal, please select "Memory Viewer".

Network

When input source is from network connected to LAN terminal with LAN cable, please select "Network".

USB Display

When input source is from the device connected to USB terminal, please select "USB Display".

Remote control

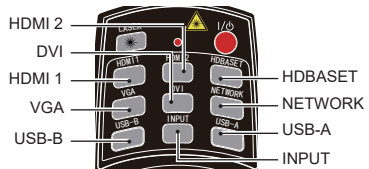

Control Panel

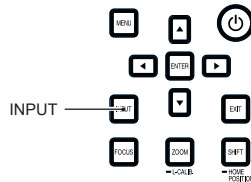

Input select menu

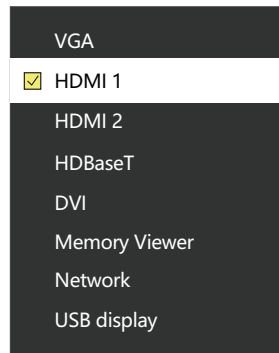

✓ Note:

- When the "Input search" function is set to "On" in the "Auto setup" function, the input signal will be searched automatically.
- When input signal is from "USB Display", "Memory Viewer" and "Network", the FREEZE, ASPECT, IMAGE, AUTO SETUP, TEST PATTERN and SCREEN function cannot work.

OSD Setting-Display







Auto PC Adjusting

The Auto PC Adjusting function may get Total Dots, Horizontal and Vertical position, Display area H, and Display area V aligned with computer input.

Direct Operation

Press Auto button on the remote control to launch the Auto PC Adj. function.

Menu Operation

- 1 Press the  MENU button on the control panel or the MENU button on the remote controller and the OSD displays. Press   button to select Display icon. Press  button or OK button and the Display menu displays.
- 2 Press   button to point to Auto PC Adj. option, press OK button to launch it.

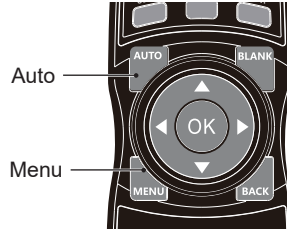

Display menu

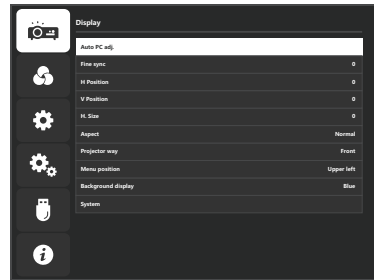

✓ Note:

- The projector executes the Auto PC adjustment automatically when the computer signals input the projector for the first time.
- Auto PC adjustment may not work depending on the model of the computer and the input signal.
- The Auto PC adjustment cannot be operated when 480i, 576i, 480p, 576p, 720p 1080i or 1080p is selected in the "Display" menu → "System", or when the signal is coming from the HDMI terminal.

OSD Setting-Display

Manual PC signal format adjustment

The scan system of your projector may fail to detect signal format used by certain computers as they opted some special signal format. The manual computer adjustment function of your projector enables you to adjust individual parameter to align with most special signal format.

- 1 Press MENU button on the remote controller or control panel and the OSD displays. Press ▲▼ button to select Display icon, press ► button or OK button to confirm your selection.
- 2 Press ▲▼ button to select items for adjustment, press ► button or OK button to confirm your selection or press ▲▼ button to adjust settings.

Auto PC adj.

Adjust [Fine sync], [H Position], [V Position] and [H Size] automatically.

Fine Sync

Eliminate flashes in image. Press ▲▼ button to adjust Total Dots. (From 0 to 31)

H Position

Press ▲▼ button to adjust horizontal position of image.

V Position

Press ▲▼ button to adjust vertical position of image.

H size

Adjust and minimize the effect of interference caused by projection of patterns consisting of vertical stripes.

The projection of the vertical striped pattern may cause cyclic patterns (noise). Adjust to minimize the amount of interference.(From -15 to +15).

Note: H.Size must be set before adjust Fine sync.

Aspect

Press ▲▼ button to choose the selection to set the screen size to fit the image while maintaining the aspect ratio of the input signal.

Normal.....Projects the image at the maximum size while maintaining the aspect ratio of the input signal.

16:9.....Projects the image at 16:9 aspect ratio.

16:10..... To provide an image to fit the screen.

(*Only for VGA and HDMI input signal)

Auto PC adj. Menu

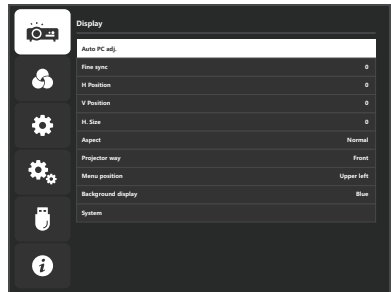

✓ Note:

- The projector executes the Auto PC adjustment automatically when the computer signals input the projector for the first time.
- Auto PC adjustment may not work depending on the model of the computer and the input signal.
- The Auto PC adjustment cannot be operated when 480i, 576i, 480p, 576p, 720p 1080i or 1080p is selected in the "Display" menu → "System", or when the signal is coming from the HDMI terminal.

✓ Note:

- The adjustment of Fine sync, H Position, V Position and H.Size is only for computer signal input.
- The Fine Sync, Total Dots and Clamp function will be disabled if 480i, 576i, 480p, 576p, 720p, 1080i or 1080p has been selected in the system menu.

OSD setting-Display

Project way

Press ▲▼ button to select the project way.

FrontProjects to front screen when projector is front standing.

RearProjects to rear screen when projector is front standing.

Ceiling/Front Projects to front screen when projector is in ceiling state.

Ceiling/Rear Projects to rear screen when projector is in ceiling state.

Auto Ceiling/Front: Projects to front screen when projector is in ceiling state automatically.

Auto Ceiling/Rear: Projects to rear screen when projector is in ceiling state automatically.

Menu position

Press ▲▼ button to select the position of the on screen menu.

Upper leftMenu locates on upper left of the screen.

Upper rightMenu locates on upper right of the screen.

CenterMenu locates at the center of the screen.

Lower leftMenu locates on lower left of the screen.

Lower rightMenu locates on lower right of the screen.

Background display

Press ▲▼ button to select the screen background of the projector when there is no signal detected.

Black Select black background.

Blue Select blue background.

System

The projector automatically tunes to various types of computers with its function of Multi-scan system and Auto PC Adjustment. If a computer is selected as a signal source, the projector automatically detects the signal format and tunes to project proper images without any additional setting.

One of the following messages may appear when input source as computer:

Auto

When the projector cannot recognize the connected signal conforming to the provided computer system, Auto is displayed on the System menu box and the Auto PC Adj. function works to display proper images. If the image is not projected properly, a manual adjustment is required.

There is no signal input from computer. Check the connection between your computer and projector.

VIDEO system menu

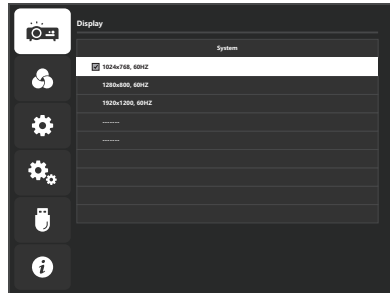

✓ Note:

- When input signal as HDMI 1, HDMI 2, Memory Viewer, Network or USB display is selected, System menu for computer will disable.

OSD setting-Color Adjust

Color Adjust

Menu operation

- 1 Press the MENU button on remote controller and the OSD displays. Press ▲▼ button select Color Adjust icon, press ► button or OK button to confirm your selection.
- 2 Press ▲▼ button to point to required item and press OK button to confirm your selection.

Image mode

Switch image mode to fit the image source and the projector. (default setting is Standard)

Dynamic

The light output is maximized for use in bright room.

Standard

Normal picture level preset on the projector.

Cinema

Enriched grayscale for viewing movies.

Blackboard (Green)

An image mode designed for displaying on a blackboard (Green). It boosts quality of image projected on blackboard (Green). This is designed for a board in green rather than black as indicated by its name.

DICOM

A highly clear X-ray image is reproduced. Digital radiographs with excellent detail and clarity for medical training, presentations and conferences.

Colorboard

Image mode suitable for image projecting on surface of wall in red, blue, yellow or green.

User Image

Default image mode set by users in the Image Adjust menu.

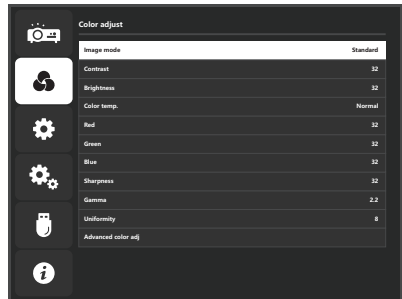

Contrast

Press ▼ button to decrease contrast, press ▲ button to increase contrast.

Brightness

Press ▼ button to decrease brightness, press ▲ button to increase brightness

Color Temp.(for VGA/HDMI input source only)

Press ▲▼ button to select required color temperature

High: Blueish image color

Mid.: Natural image color

Low: Reddish image color

Red

Press ▼ button to lighten red tint and ▲ button to darken it.

Green

Press ▼ button to lighten green tint and ▲ button to darken it.

Blue

Press ▼ button to lighten blue tint and ▲ button to darken it.

Sharpness

Press ▼ button to soften image and ▲ button to sharpen it.

OSD setting-Color Adjust

Gamma

Press ▼▲ button to select appropriate gamma setting for different environment.

- 1.8: Project with the brightest image
- 2.0: Project with the brighter image than default setting.
- 2.2: Default setting for the brightness of image.
- 2.4: Project with the darker image than default setting.
- 2.6: Project with the darkest image

Uniformity

Press ▼▲ button to adjust the color uniformity of the image from 0 to 8

✓ Note:

- Uniformity is related to the projected image. Adjust the Focus of the image, and arrange the dimension of the image and the projection distance would help to get the better color uniformity of the image.
- The default "Focus" maximum screen size value is 0, and the "Focus" minimum screen size value is 8 with the best picture effect as well..

Advanced color adj.

Press ▼▲ button to select the item you would like to arrange.

- Hue: Arrange the hue level of the projection image
- Luminance: Adjust the brightness of the projection image.
- Saturation: Arrange the saturation of the projection image.

OSD setting-Setting

Setting

Your projector comes with convenient adjustment function.

- 1 Press the MENU button on remote controller and the OSD displays. Press ▲▼ button to select Setting icon, press ► button or OK button to confirm your selection.
- 2 Press ▲▼ button to point to required item and press OK button to confirm your selection.

Direct power on

Setting the projector to be turned on automatically just by connecting the AC power cord.

- On ... Start the projection immediately.
- OffStart up in the standby mode.

✓ Note:

- There need to wait for 30 seconds to power on the projection again after unplug-replug the power cord.
- The projector can not power on immediately after unplug-replug the power cord.

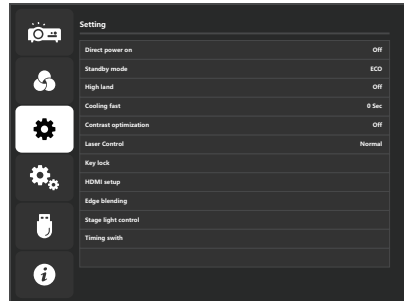

Standby mode

Setting the power consumption in standby mode.

- Eco.....Restrict some functions in thestandby mode to reduce power consumption. In this case, you could control the projector with limited.
- Normal ...Do not restrict network function and serial communication function even in the standby mode.
- Network...Power on the projector via Wake on LAN software.

High land

Control the fan speed while cooling according to the operating condition.

- Off ... Normal speed. Set it so if the projector is operated at a lower altitude.
- On ... Faster than Off. Set it so if the projector is operated at a higher altitude.
- Auto. Enable the High land function automatically.

✓ Note:

- When operating the projector at an altitude around 1400~2700m, please setting as ON.

Cooling fast

provides the following options in the cooling fans' operation after turning off the projector.

- Normal .. As default cooling time.
- 30 sec ... Faster cooling time and louder noise of fan.
- 0 sec Allow you to unplug the AC power cord immediately without cooling.

Contrast optimization

Select this function to optimize and compensate signal automatically on the basis of the image, to get the best contrast image.

- On Increase the contrast of the image.
- Off Disable this function.

OSD setting-Setting

Laser Control

Modify the brightness according to the environment and the aim during the projectino.

Light source mode:

Normal.....90% brightness of full power of light source as default.

Full Normal.....100% brightness of full power of light source.

ECO.1/ECO.2...Lower the brightness and reduce energy consumption.

Laser adjust.:

50% ~ 100%Arrange the brightness according the setting.

✓*Note:*

This adjustment can only launched while the Light source mode as Normal.

Keylock

Set the security for the projector operation.



Off...The control panel and remote controller are effective.



Projector...Lock the operation of the control panel. Use the remote control to unlock.



Remote Control ...Lock the operation of the remote control. Use the control panel to unlock.

✓ *Note:*

If the control panel accidentally becomes locked and you do not have the remote control nearby or there is something wrong with your remote control, contact the dealer where you purchased the projector or the service center.

Remote control

Prevent the interference from the remote controller while multiple projectors or video devices are operated at the same time. (default setting is Code 0)

Change code on Projector: _

Code 0 ~ code 9 Select the specified ID number to control the individual projectors.

Change code on remote controller: _

Press and hold the OK button with one of the number button for 5 seconds to set the code as the number you pressed. The code is set successfully when the light indicator on the remote controller flashed.

✓ *Note*

The projector and the remote controller must be paired with the same code.

HDMI setup (for HDMI input source only)

Switch the settings of "Image" or "Sound" in "HDMI setup" menu, if the image is not projected properly.

Image

64-940 / 0-1023.....Switch the signal level to project the image with special input signal.

Auto Switch the signal level automatically.

✓*Note:*

The optimal setting varies depending on the output setting of the connected external device. Refer to the operation instruction of the external device regarding the output of the external device.

Sound

HDMI The image and audio are transmitted.

VGA The audio signal is input by "AUDIO IN" terminal.

OSD setting-Setting

Edge blending(for HDMI input source only)

Adjust the edge of projection image of multiple projectors to project the large image with indistinguishable edge.

Edge blending

On: Enable the edge blending function

Off: Disable the edge blending function

Area setting

Boundary line: Set the Boundary line as Off / Line / Grid

Left / Top / Right / Bottom: Enable boundary line with the blending edge at left / top / right / bottom of the projector.

Left Range / Top Range / Right Range / Bottom Range: Adjust the edge line on at left / top / right / bottom of the projector.
The default adjustment range is 20%.

White balance

R / G / B gain: Adjust the brightness and color gain value for Red / Green / Blue of the image.
The default value is 32.

Press ▲▼ button to adjust the value.

R / G / B offset: Fine-tune the brightness and color gain value for Red / Green / Blue of the image. The default value is 32.

Press ▲▼ button to adjust the value.

Reset: Reset the setting value and get back with default value.

Image edge adj.

Blending Area (Left / Top / Right / Bottom / Other): Select the edge blending area as target to adjust the value.

Level (Level 0 / Level 1 / Level 2 / Level 3 / Level 4 / Level 5): Setting the brightness level of the edge blending area.

R / G / B: adjust the color of the edge blending area.

Gain: Select the level of color gain of the edge blending area.

Reset: Reset the setting value and get back with default value.

EB keystone

EB 4D keystone: Correc the distortion for the edge blending area with 4 corneq correction function.

Grid Image Tune: Tune the distortion for the edge blending area with grid point.

Reset: Reset the setting value and get back with default value.

Advanced

H Total: Determine the total quantity of projector that use to setting the edge blending at horizontal row.

V Total: Determine the total quantity of projector that use to setting the edge blending at vertocal column.

H Position: Determine the projector position of the horizontal rows.

V position: Determine the projector position of the vertocal columns.

H Range 1: Setting the width of the first blending area that counting from left.

H Range 2: Setting the width of the second blending area that counting from left.

H Range 3: Setting the width of the third blending area that counting from left.

V Range 1: Setting the width of the first blending area that counting from top.

V Range 2: Setting the width of the second blending area that counting from top.

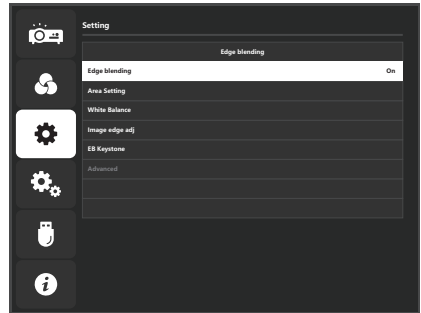

OSD setting-Setting

Stage Light Control

Enable the DMX512 controller to achieve synchronous control or separate control of multiple projector at the same time, so as to control the stage light.

Stage light control

On: Enable the stage light control function

Off: Disable the stage light control function

Projector ID:

0 ~ 12 Select the ID of the projector to suitable the ID setting of the DMX512 controller.

Timing Switch

Timing switch

On: Enable the timing switch function

Off: Disable the timing switch function

Operating time

Sunday ~ Saturday: Select the operating day by weekly

Time setting

Setting the operation time of projector.

OSD setting-Expand

Expand

Select the Expand menu to set up other functions of your projector.

1. Press the MENU button on remote controller and the OSD displays. Press ▲▼ button to select Expand icon, press ► button or OK button to enter the submenu.
2. Press ▲▼ button to point to required item, press ► button or OK button to confirm your selection.
3. Press ▲▼ button to point to required item, press OK button to confirm your selection.

Language

This projector provides multi-language screen menu.

You can press ▲▼ button to select the language you want: English, German, French, Italian, Spanish, Polish, Swedish, Dutch, Portuguese, Japanese, Simplified Chinese, Traditional Chinese, Korean, Russian, Arabic, Turkish, Finnish, Norwegian, Danish, Indonesian, Hungarian, Czech, Kazakh, Vietnamese, Thai and Farsi.

Auto setup

Press AUTO button on the remote control to execute "Input search" and "Auto PC adj." functions.

Input search

Allows you to automatically detect input signals. It stops when a signal is found. Press ▲▼ button to select an option below:

- On.....Enabled.
- Off.....Disabled.

Auto PC adj.

- On.....Press the AUTO button on the remote control to enable Auto PC adj. function automatically.
- Off.....Cancel Auto PC adj. function.

✓ Note:

- "Input search" and "Auto PC Adj." cannot be set to "Off" at the same time. At least one of them is set to "On".
- The setting of "Input search" as "On", the projector would start searching input signal while power on the projector.

Expand menu

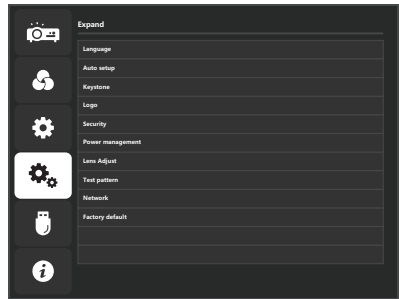

Auto setup

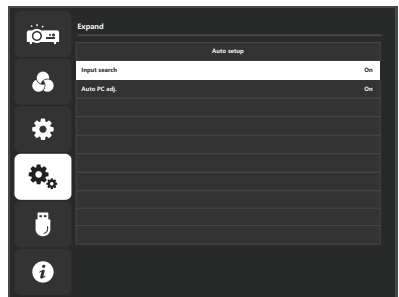

OSD setting-Expand

Keystone

This function is used to correct the distortion image.

Keystone

Sets whether or not to keep the keystone correction after turn off the projector or plug out the power cord.

Store.... The keystone correction will be kept after unplug the power cord or turn off the projector.

Reset... The keystone correction will be canceled after unplug the power cord or turn off the projector.

H/V Keystone

Adjust when the horizontal or vertical trapezoid of the projected image is distorted.

Reduce the upper width with ▲ button.

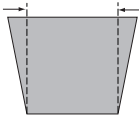

Reduce the lower width with ▼ button.

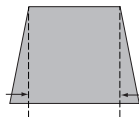

Reduce the left width with ◀ button.

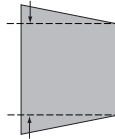

Reduce the right width with ▶ button.

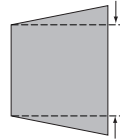

✓ Note:

- The white arrows indicate that there is no correction.
- A red arrow indicates the direction of correction.
- An arrow disappears at the maximum correction.

6-Corner correction

Adjust when the six corners of the projected image are distorted.

Press ▲ ▼ ◀ ▶ to adjust the item.

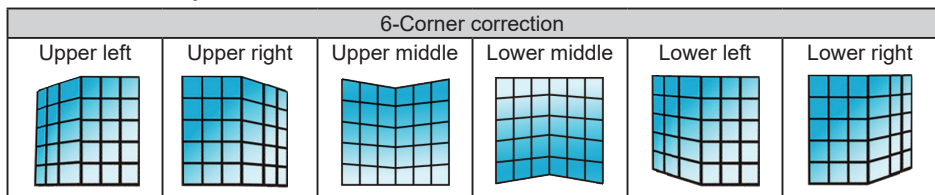



OSD setting-Expand

Curved correction

Adjust when the linearity is not uniform or the vertical and horizontal lines are distorted.

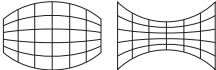
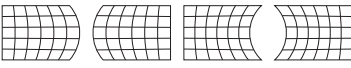
Press ▲▼◀▶ to adjust the item.

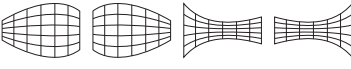
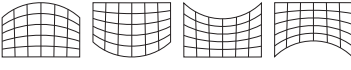
Items	Operation	Adjustment
Curved correction - X/Y Gain	Press the ◀ & ▶ button	Adjust the right & left of the width 
	Press the ▲ & ▼ button	Adjust the top & bottom of the width 
Curved correction - X Offset	Press the ◀ / ▶ button	Adjust the left / right of the distortion 
	Press the ▲ / ▼ button	Adjust the top / bottom of the distortion 
Curved Correction - Y Offset	Press the ◀ / ▶ button	Adjust the left / right of the distortion 
	Press the ▲ / ▼ button	Adjust the top / bottom of the distortion 

✓ Note:

- The adjusted value will be reset when you switch the keystone correction with another one.
- The "Curved Correction X Offset" and the "Curved Correction Y Offset" can not be adjusted independently. After adjusting the "Curved Correction X/Y Gain" at the beginning, please adjust the "Curved Correction X Offset" and "Curved Correction Y Offset".
- Correcting up to $\pm 30^\circ$ for the tilt in the vertical direction and $\pm 15^\circ$ for the tilt in the horizontal direction are available for adjustments with "Keystone". However, the image quality will degrade and it will get harder to focus with more correction. Install the projector so that the correction will be as small as possible.
- Screen size will also change when "H/V Keystone" is used to perform various adjustments.
- Aspect ratio of the image size may shift depending on the correction.

Reset value

Return the corrected values to the factory default values.

Press ▲▼ to select "Reset value", and then press the OK button, the state of the keystone correction is released.

OSD setting-Expand

Logo

This function allows you to customize the screen logo with Logo select, Capture, Logo PIN code lock and Logo PIN code change functions.

Logo Select

This function decides on the starting-up display from following options.

- Default . Show the factory-set logo.
- User..... Show the image captured by user.
- Off..... Show the countdown display only.

Capture

You can capture a projected image as start logo . Select "Capture" and press the OK button on remote control or control panel. Confirmation dialog box appears, select "Yes" to start capturing.

✓ *Note: The captured user logo image is deleted when factory default is executed.*

Logo

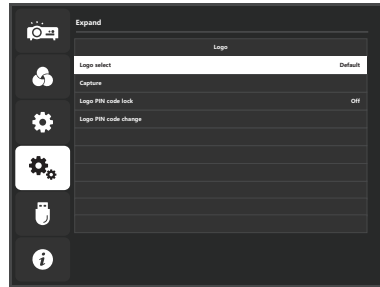

Logo PIN code Lock

This function prevents an unauthorized person from changing the screen logo.

Off The screen logo can be changed freely from the Logo menu.

On The screen logo cannot be changed without a Logo PIN code.

If you want to change the Logo PIN code lock setting, press the OK button and the Logo PIN code dialog box appears. Enter a Logo PIN code by following the steps below. The default PIN code is "111".

Press OK button to enter the PIN code. Press ◀▶ button to select a number, and then press the OK button to enter this number, the cursor automatically move to next box. If you fixed an incorrect number, press MENU button to reset it again.

Repeat this step to complete entering a three-digit number.

After entering the three-digit number, the cursor automatically move to "Set", and press the OK button, then you can start to operate the projector.

If you entered an incorrect PIN code, the number (***) turn red, it will be reset automatically within one second. Enter the correct PIN code all over again.

Logo PIN code change

You can change the Logo PIN code (three number). Press the OK button to select Logo PIN code change. Logo Pin code dialog box appears, press ◀▶ button to enter the correct PIN code. The New Logo PIN code input dialog box appears. Set a new Logo PIN code, confirmation box appears, select Yes to set the new Logo Pin code.

Be sure to note the new Logo PIN code and keep it on hand. If you lost the number, you could no longer change the Logo PIN code setting.

CAUTION:

WHEN YOU HAVE CHANGED THE LOGO PIN CODE, WRITE DOWN THE NEW PIN CODE IN COLUMN OF THE LOGO PIN CODE NO. MEMO ON PAGE 99, AND KEEP IT SECURELY. SHOULD THE LOGO PIN CODE BE LOST OR FORGOTTEN, THE LOGO PIN CODE SETTING CAN NO LONGER BE CHANGED.

OSD setting-Expand

Security

This function allows you to use the PIN code lock and PIN code change functions to set the security for the projector operation.

PIN code lock

This function prevents the projector from being operated by unauthorized persons and provides the following setting options for security.

Off Unlocked.

On Enter the PIN code every time while power on the projector. If you want to change PIN code lock setting or PIN code, you must enter the PIN code.
The default PIN code is "111".

If you want to change the PIN code lock setting, press the OK button, then PIN code dialog box appears.

Enter the PIN code

Press ◀▶ button to select a number, and then press the OK button to enter this number, the cursor automatically moves to next box. If you fixed an incorrect number, press MENU button to reset it again.

Repeat this step to complete entering a three-digit number.

After entering the three-digit number, the cursor automatically move to "Set", and press the OK button, then you can change the PIN code lock setting.

If you entered an incorrect PIN code, the number (***) turn red, it will be reset automatically within one second. Enter the correct PIN code all over again.

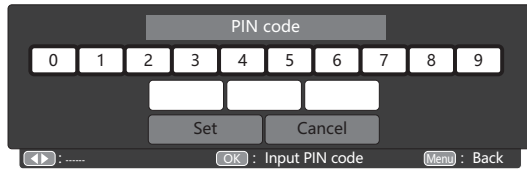

PIN code change

The PIN code can be changed to three-digit number. Press ▲▼ button to select PIN code change. Pin code dialog box appears, Press ◀▶ button to enter the correct code. The New PIN code input dialog box appears. Set a new PIN code.

Forget the PIN code

Press the [POWER] and [ENTER] button on the projector at the same time first, then plug the power cord in, and keep pressing the [POWER] and [ENTER] button on the projector together for a while, the "PIN code" screen appears. Enter the default PIN code as "111".

Select [Security]→[PIN code lock]→ [On]. As the [PIN code] screen appears again, enter the default password (111) and set a new passcode.

Security

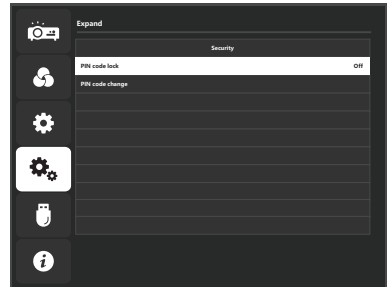

CAUTION:

WHEN YOU HAVE CHANGED THE PIN CODE, WRITE DOWN THE NEW PIN CODE IN COLUMN OF THE PIN CODE NO. MEMO ON PAGE 99, AND KEEP IT SECURELY. SHOULD THE PIN CODE BE LOST OR FORGOTTEN, THE PIN CODE SETTING CAN NO LONGER BE CHANGED.

OSD setting-Expand

Power management

For reducing power consumption as well as maintaining the lamp life, the Power management function turns off the projection lamp when the projector is not operated for a certain period. Select one of the following options:

Ready - When the lamp has been fully cooled down, the POWER indicator changes to green blinking. In this condition, the projection lamp will be turned on if the input signal is reconnected or any button on the remote control or control panel is pressed.

Power off - When the lamp has been fully cooled down, the power will be turned off.

Off - Disable the Power management function.

Timer - If the input signal is interrupted and no button is pressed for more than 30 seconds, the timer display with No signal appears. It starts the countdown until the lamp is turned off. Press ▲▼ button to set the Timer(1~30min.)

Ready countdown - Set the time that ready status transfers to standby status automatically.(0-30min. 0 Min: not transfer automatically)
In ready status, press POWER button to switch to standby status, and press any other button to turn on the projector.

Power management

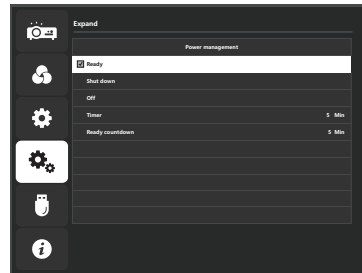

Countdown timer .

✓ Note:
Factory default: "Timer: 5 min",
"Ready countdown: 5 min".

Lens Adjust.

Set this function to adjust the lens, so as to adjust its size and clarity of the projected image to achieve the best projection effect.

Lens position

Lens position: Select the saved lens position from 1 - 3 and Auto.

Store: Save the current setting as lens position.

Apply: Apply the setting of lens position.

Focus.....Adjust the focal length of the projected image to make it more clear.

Zoom.....Zoom in or out to the projection image.

Lens shiftReposition the projection image by move the lens position via this function.

Lens center....Move the lens back to the center position.

Lens calibration.....Calibrating the projection lens.

Test Pattern

This function is used to set the internal test pattern: Gray scale 1, Gray scale 2, Gray scale 3, Gray scale 4, Color bar, Red, Green, Blue, Cross hatch, White, Black and Raster gray.

OSD setting-Expand

Network

Function : PC controls projector via LAN.

Preparation:

1. Equipments: PC, projector, cables
2. Connection procedures:
Connect the projector to routers or switches of the LAN by direct or cross cable. If it fails to connect PC and projector by parallel cable, please switch to cross cable as suggested.
3. After the computer is booted and the projector is plugged in, indicator lights of LAN interface on will flash continuously.

Operation procedures:

- 1 Turn on the projector.
- 2 Obtain network address. DHCP set is displayed as On and obtain network address automatically. (If familiar with network, you can set DHCP as Off and obtain network address manually)
- 3 Enter network settings menu.

(1) Press MENU button on the remote control to display OSD menu. Press ▲▼ button to select Expand icon, and then press the OK button.

(2) Press ▲▼ button to select Network, and then press the OK button to enter the network menu.

MAC address ... Displays the MAC address of wired network of this projector.

IP addressDisplays the IP address of wired network of this projector.

(3) DHCP setting as On, IP address, Subnet, Gateway and DNS will be obtained automatically, press the OK at "Set" to confirm the parameters.

DHCP setting as Off, press the OK button to enter IP address, then press ▼ button to enter Subnet, Gateway and DNS respectively, press the OK at "Set" to confirm the parameters.

✓ **Note:**

See page 70 for usage of Network.

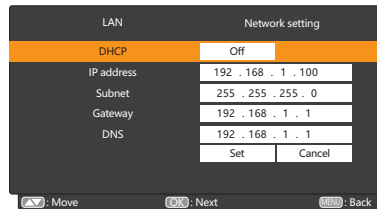
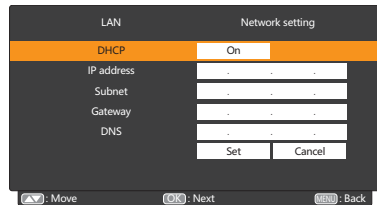

Factory default

This function returns all setting values except for the PIN code lock, Logo PIN code lock and Light source counter to the factory default settings.

✓ **Note:**

Press the "Menu" button to cancel launch the factory default process.

OSD setting-Memory Viewer

Memory Viewer(for Memory Viewer input only)

The Memory Viewer function allow to project the pictures which are stored in the USB memory Device. This function only available when the USB memory device inserted into the projector.

- 1 Press MENU button on the remote control to display screen menu.
- 2 Press ▲▼ button to select "Memory Viewer", then press the OK button.
- 3 Press ▲▼ button to select the item you want to set, press the OK button.
- 4 Press ▲▼ button to adjust the item, then press the OK button.

Set Slide

Start the slide show.

Slide transition effect

Set the slide transition effect while the images switching as slide show.

Slide down.....Switch the image from the top to the bottom.

Slide right..... Switch the image from the left to the right.

Press▲▼to select "Apply" and press the OK button to execute the setting.

Sort Order

Set the sort order of the slide show.

Extend OrderSort files or folders in extended order.

Size OrderSort files or folders in amount of data order.

Time OrderSort files or folders in stored time order.

Name Order.....Sort files or folders in name order.

Press▲▼to select "Apply" and press the OK button to execute the setting.

Rotate

Set the rotate direction of image.

No Rotate Rotate is disabled.

270 Degrees Rotate 270 degrees in anti-clockwise direction.

180 Degrees Rotate 180 degrees.

90 Degrees..... Rotate 90 degrees in anti- clockwise direction.

Press▲▼to select "Apply" and press the OK button to execute the setting.

Best Fit

Set the image whether or not to fit with the projected screen.

On.....Display the image to fit with the aspect of the projected screen.

Off.....Display in the normal pixels of the image.

Press▲▼to select "Apply" and press the OK button to execute the setting.

Repeat

Enable or disable repeat function of the slide show.

On.....Display all of the files repeatedly.

Off.....Return to the thumbnail page after the last file is broadcasted.

Press▲▼to select "Apply" and press the OK button to execute the setting.

Apply

Execute the setting in slide show mode.

Press ▲▼ to select "Apply", then press the OK button, to launch the setting effect of slid show.

OSD setting-Info.

Information

The information menu is used to detect signal of projected image and running state.

Menu operation

Press MENU button on the remote control or control panel to display the screen menu.

Press ▲▼ to select Info., the information menu will appear as the right picture.

The status of projector will display in information menu.

Input

The selected input source is displayed.

H-sync freq .

The horizontal frequency of the input signal is displayed in KHz or - - - -KHz when no signal is detected.

V-sync freq .

The vertical frequency of the input signal is displayed in Hz or - - - - Hz when no signal is detected.

Light source counter

The usage time of the lamp is displayed.

Power management

The setting status of "Power management" is displayed.

Image mode

The setting status of "Image mode" is displayed.

info. menu

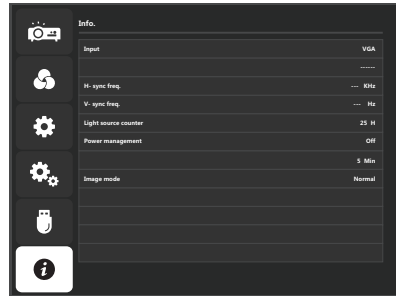

Description on using
useful function

Description on network control operation

LAN control

Function : PC controls projector via LAN.

Preparation:

1. Equipments: PC, projector, cables
2. Connection procedures:

Connect the projector to routers or switches of the LAN by direct or cross cable. If it fails to connect PC and projector by parallel cable, please switch to cross cable as suggested.

3. After the computer is booted and the projector is plugged in, indicator lights of LAN interface and computer interface will flash continuously.

Operation procedures:

- 1 Turn on the projector.
- 2 Obtain network address. DHCP set is displayed as on and obtain network address automatically. If familiar with network, you can set DHCP as close and obtain network address manually.

- 3 Enter network settings menu.

(1) Press MENU button on control panel or remote control to display screen menu. Press ▲▼ button to select "Expand" icon, then press the OK button.

(2) Press ▲▼ button to select "Network" setting and press the OK button enter the network setting.

(3) Press ▲▼ button to set DHCP as on.

(4) Press ▲▼ button to "Set" and press the OK button. "Please wait..." appears.

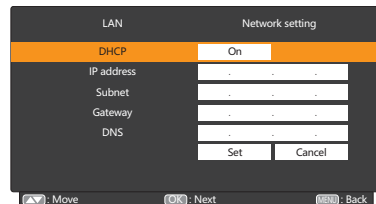

Description on network control operation

4. Activate the Web browser in the personal computer.
5. Enter the IP address + /html (i.e. "192.168.1.100/html") set by the projector into the URL input field of the Web browser.
(When entering the IP address only, Web browser will open Crestron Roomview page.)
6. Select "Login" to login the Network Display System page. (Both the initial name and passwords are "admin".)



✓ **Note:**

- You can click the upper right corner of the web browser screen to select the display language.
 - Do not perform setting or control simultaneously by starting up multiple web browsers. Do not set or control the projector from multiple computers.
 - Change the password first. (8 half-width characters).
 - If the screen for the web control is not displayed, consult your network administrator.
7. Items in Network Display System page including: "System Status", "General Setup", "Picture Setup", "Image Setup" and "Network Setup".

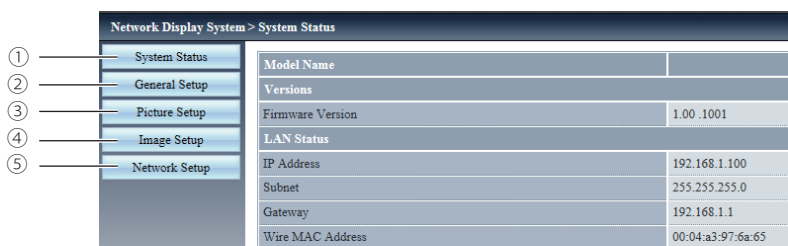

- ① **System Status**
The "System Status" page is displayed by clicking this item.
- ② **General Setup**
The "General Setup" page is displayed by clicking this item.
- ③ **Picture Setup**
The "Picture Setup" page is displayed by clicking this item.
- ④ **Image Setup**
The "Image Setup" page is displayed by clicking this item.
- ⑤ **Network Setup**
The "Network Setup" page is displayed by clicking this item.

Description on network control operation

"System Status" page

Display the status of the projector for the following items.

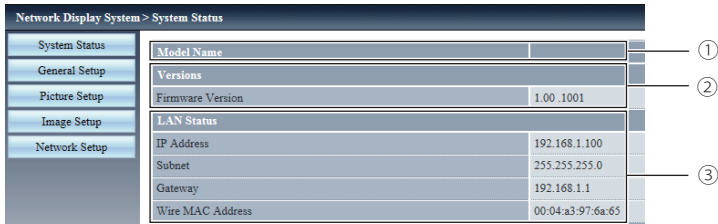

- ① Model Name
Displays the model No. of the projector.
- ② Versions
Displays the version of the firmware of the projector.
- ③ LAN Status
Displays the connection status of the LAN.

"General Setup" page

Change Password for Webpage is displayed.

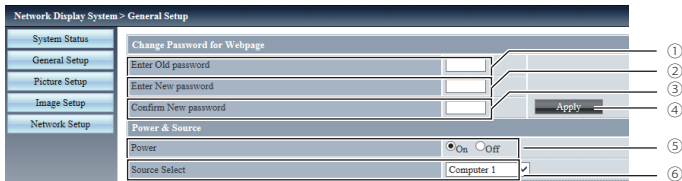

- ① Enter Old password
Enters the configured password.
- ② Enter New password
Enters the new password.
- ③ Confirm New password
Enters the wanted new password again for confirmation.
- ④ Apply
Updates the settings.
- ⑤ Power
Switches on/off the power of the projector.
- ⑥ Source Select
Switches the input source of the projector.

"Picture Setup" page

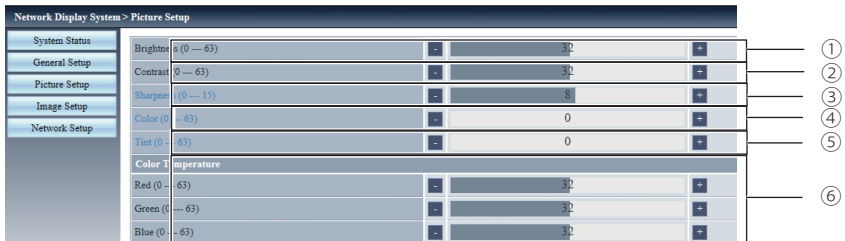

Description on network control operation

- ① Brightness
Adjusts the brightness of the projected image.
- ② Contrast
Adjusts the contrast of the projected image.
- ③ Sharpness
Adjusts the sharpness of the projected image.
- ④ Color
Adjusts the color saturation of the projected image.
- ⑤ Tint
Adjusts the skin tone of the projected image.
- ⑥ Color Temperature
Adjusts the color temperature of the projected image.

"Image Setup" page

The screenshot shows the 'Image Setup' page of a Network Display System. The page is divided into several sections, with 'Image Setup' selected. The settings are as follows:

Setting	Value	Unit
Aspect	Normal	
Fine sync (0 ... 31)	0	
H Position	0	
V Position	0	
H Size (-15 ... 15)	0	
Freeze	Off	
V Keystone (-60 ... 60)	0	
H Keystone (-30 ... 30)	0	
Curved correction XGain (-40 ... 40)	0	
Curved correction YGain (-40 ... 40)	0	
Curved correction XOffset_x (0 ... 1279)	640	
Curved correction XOffset_y (0 ... 799)	400	
Curved correction YOffset_x (0 ... 1279)	640	
Curved correction YOffset_y (0 ... 799)	400	
Corner correction TopLeft_x (0 ... 1279)	0	
Corner correction TopLeft_y (0 ... 799)	0	
Corner correction TopRight_x (0 ... 1279)	1279	
Corner correction TopRight_y (0 ... 799)	0	
Corner correction BottomLeft_x (0 ... 1279)	0	
Corner correction BottomLeft_y (0 ... 799)	799	
Corner correction BottomRight_x (0 ... 1279)	1279	
Corner correction BottomRight_y (0 ... 799)	799	

- ① Aspect
Switches the aspect of the projected image.
- ② Fine sync
Adjusts the fine sync of the projected image.
- ③ H Position
Adjusts the horizontal position of the projected image.
- ④ V Position
Adjusts the vertical position of the projected image.
- ⑤ H.Size
Adjusts the total number of dots of the projected.
- ⑥ Freeze
Switches the freeze function between on and off.
- ⑦ Auto PC adj.
Executes the Auto PC adj. function.
- ⑧ V Keystone
Corrects the keystone in vertical direction.
- ⑨ H Keystone
Corrects the keystone in horizontal direction.
- ⑩ Curved Correction
Corrects the pincushion or barrel of the projected image.
- ⑪ Corner correction
Corrects the four corners of the projected image.

Description on network control operation

"Network Setup" page

Obtain an IP address automatically		Use the following IP address	
IP Address	192	168	1 100
Subnet	255	255	255 0
Gateway	192	168	1 1
DNS	192	168	1 1

① LAN Setup

Select [Obtain an IP address automatically] if you want to enable the DHCP client.

IP Address

Enter the IP address when not using a DHCP server.

Subnet

Enter the subnet mask when not using a DHCP server.

Gateway

Enter the default gateway address when not using a DHCP server.

DNS

Enter the DNS server when not using a DHCP server.

② Apply

Updates the settings.

Description on network display operation

Network Display function

1. PwPresenter software: when "Network" is selected in Source Select, you can project the current computer images via network.

Input the IP address of the projector in webpage to enter the Network Display System, click "Download" to download the PwPresenter software according to your operation system.

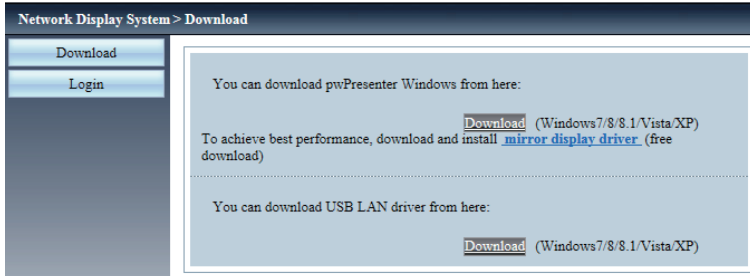

2. Launch the pwPresenter software.

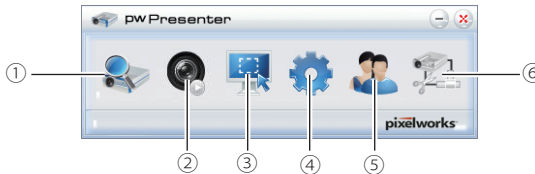

① Search for projector display
Click to enter Search, select the projector and connect it. Please setting the same IP address of the projector in pwPresenter software, (such as: 192.168.1.100). Both the initial name and passwords are "admin".

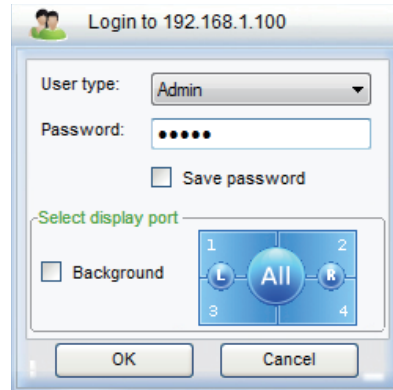
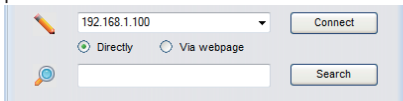

✓ *Note:*

- Before use PwPresenter software to search, you need change Source Select to "Network".

Description on network display operation

② Play/Pause

Play or pause the selected image.

③ Choose capture mode

Choose a capture mode from "Full Screen", "Fixed Size" or "Alterable."

④ Parameters Setting

Basic Setting

Setting language, region of capture image etc.

The screenshot shows the 'Basic Setting' dialog box with the following options:

- Language select: English
- Region size of fixed size capture mode: 800 x 600 (pixels)
- Enable mirror driver when startup if there is.
- Allow notification message popup: Yes No
- Data Transfer Encryption: None Partial Full
- Software Information:
 - Version number: pwPresenter PCS1.0
 - Manufacturer: Pixelworks
 - Frame rate: []

Buttons at the bottom: OK, Apply, Cancel, Default.

Advanced Setting

Setting image quality, network port etc.

The screenshot shows the 'Advanced Setting' dialog box with the following options:

- Jpeg image setting:
 - Quality: High
 - YUV sample format: YUV444 YUV420
- Network port setting:
 - Fixed Manual (5900)
 - Allow resolution to be changed: Yes No
- White list and Black list:
 - Devices allowed: []
 - Devices banned: []

Buttons at the bottom: OK, Apply, Cancel, Default.

Global Setting

Setting remote control, capture by audio or screen etc.

The screenshot shows the 'Global Setting' dialog box with the following options:

- Allow remote control: Yes No
- Allow audio capture: Yes No
- Allow screen capture: Yes No
- Sound volume: [Slider] 20 %
- Mode: Video

Buttons at the bottom: OK, Apply, Cancel, Default.

Description on network display operation

Multicast Setting

Setting Sound volume, Bandwidth and Capture rate etc.

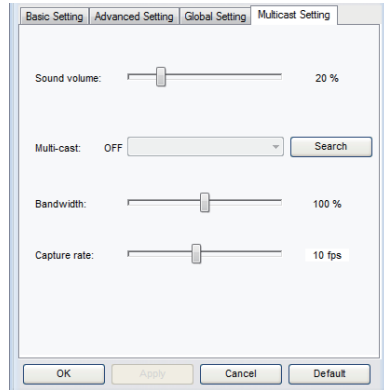

- ⑤ Network Display Management
Setting device and password management.

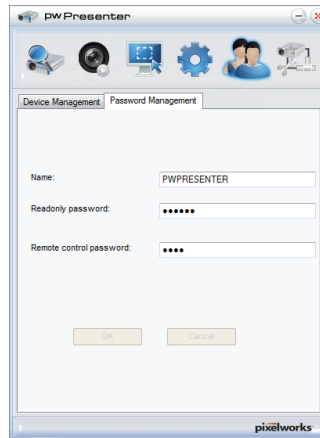
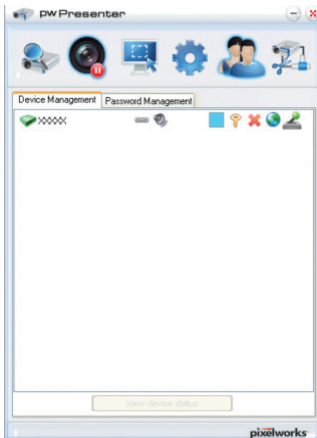

- ⑥ Disconnect the projector.

Description on using Memory Viewer function

Memory Viewer function

The Memory Viewer function is used to project the pictures which are stored in the USB memory when the USB memory is inserted into USB A(VIEWER) terminal of the projector.

Memory Viewer function supports the following image files.

	Extension	Format	Description
Picture	jpg/jpeg	Baseline encoder 24 bit	Max. resolution : 10000 x 10000
		Progressive RGB 24 bit	Max. resolution : Panel Resolution
	bmp	1, 4, 8 bit Palette-based RGB 24, 32 bit	Max. resolution : 1280 x 800
	png	24, 48 bit True color	24 bit color palette space Max. resolution : 1024 x 768
	gif	1, 4, 8 bit Palette-based	Max. resolution : 800 x 600
	tiff	—	Max. resolution : 800 x 600

Display the Memory Viewer screen

1. Press the INPUT button on the remote control or on the control panel to select the input source as Memory Viewer.
2. Insert the USB memory into the USB-A terminal of the projector directly, the standby screen appears when the USB memory icon is displayed on the screen.
3. Press the OK button on the remote control, the root directory of the USB memory will show as thumbnail on the screen.

Play the pictures

It will display a picture when play the picture manually every time.

1. Press ▲▼◀▶ to select a file on the thumbnail screen.
2. Press the OK button, the picture will display on the full screen.
3. Press ▶ to switch to the next picture, press ◀ to return to the previous picture.
4. Press the OK button on the remote control to return to thumbnail screen.

Executing the slide

All pictures in the same folder will play automatically when "Slide Transition Effect" of "Memory Viewer" menu is set to the special setting.

1. Press ▲▼◀▶ to select a file.
2. Press the "MENU" button to select the "Memory Viewer" → "Set Slide".
3. Press the OK button.
 - The picture will display on the full screen.
 - Press the OK button to return to the thumbnail screen.

Termination of the Memory Viewer

1. Press ▲▼◀▶ to the thumbnail  which is displayed on the upper left corner.
2. Press the OK button on the remote control to return to the standby screen of Press "OK".
3. Remove the USB memory directly.

Description on using Memory Viewer function



Warning

- Please ensure the right direction while insert a USB flash drive to avoid to damage the USB input terminal.

Note the following point while inserting or removing USB flash drive:

- The indicator will blinking, while inserting the USB flash drive to the projector.
- The indicator will blinking while the projector is scanning the USB flash drive.
- Do not remove the USB flash drive when the indicator is flashing.
- Do not insert and remove the USB flash drive frequently. The projector would take around 5 seconds to operation the Memory Viewer mode.

Precautions on processing and storage of USB memory

- Please place the USB flash driver at the place that children can not reach to avoid the cause of choking.
- If any smoke or abnormal smell, power off the external device and contact the dealer.
- Do not spill the water, chemicals or oil into the USB flash drive, or it may cause a short circuit or fire.
- Do not insert any foreign matter or metal items to the USB port. Static electricity may cause data loss or data damage.
- Do not remove the USB flash drive while projector is reading it, that may result the loss or corruption of data.
- Do not put the USB flash drive in high temperature, damp or dusty place, or next to magnetic materials.

Description on using USB display function

USB Display function

The USB Display function is used to project the image from the computer which is connected to USB-B (DISPLAY) terminal of the projector by a USB converting cable.

■ When using Windows

Windows operation environment

OS	Windows XP, Windows7 32/64 bit, Windows8.1 32/64 bit, Windows10 32/64 bit
CPU	Intel Core 2 Duo 2.0 GHz or faster compatible processor
Amount of memory	256 MB or more (Recommended : 512 MB or more)
Hard-disk free space	20 MB or more
Display	Resolution 640 x 480 to 1600 x 1200

- There is no guarantee for all computers that meet the above conditions will operate properly.

Projecting via USB Display

1. Connect the USB-B terminal of the projector to a computer with a USB converting cable.
2. Press the Input button on the remote controller or control panel to switch the input source as USB Display.
 - The startup screen will be displayed automatically due to the driver which is built-in the projector, and executes the installation according to the instructions of the screen. The displaying of the auto installation screen depends on the setting of computer. At this time, please select "Run autorun.exe". Please double-click "autorun.exe" in the folder of the USB Display when the automatically startup is disabled.
 - The image on the computer screen is projected.
3. Click the driver icon  in the task bar of computer and select one item in Pop-up menu.
 - Pop-up menu is only displayed in English.
 - The item which is displayed in gray is unavailable.

Active audio/ Disable audio	Set whether to output the audio from the computer.
Play video/ Pause video	Switch between play and pause the image.
Start/Stop	Set whether to display the image from the computer.
Exit	Exit USB Display.

✓ Note:

- The driver is not installed in your computer, and it will be removed from the computer when disconnecting the USB cable.
- It will take a while when you want to project the computer screen.
- Connect a USB cable directly to the USB connector of a computer. It will not work when connecting through a USB hub.

Termination of the USB display

When terminate the USB display, remove the USB cable directly. There is no need to follow "Remove hardware safely" when a USB cable is disconnected.

Description on using USB display function

■ When using Mac OS

Mac OS operating environment

OS	Mac OS X 10.5, 10.6, 10.7, 10.8, 10.10, 10.11, 10.12, 10.13
CPU	Power PC G4 1GHz or faster
Amount of memory	512 MB or more
Hard-disk free space	20 MB or more
Display	Resolution 640 x 480 to 1600 x 1200

- There is no guarantee for all computers that meet the above conditions will operate properly.

Projecting the USB Display

1. Connect the USB-B terminal of the projector to a computer with a USB converting cable.
2. Press the INPUT button on the remote control or Control panel to switch the input source to USB Display.
 - The image on the computer screen is projected.
3. Double-click "Monitor.app" in the virtual disk that has been mounted.
4. Right-click the driver icon  in the dock of computer and select one item in Pop-up menu.
 - Pop-up menu is only displayed in English.
 - The item which is displayed in gray is unavailable.

Active audio/ Disable audio	Set whether to output the audio from the computer.
Play video/ Pause video	Switch between playing and pausing the image.
Start/Stop	Set whether to display the image from the computer.
Quit	Terminate the USB Display.

✓ Note:

- It will take a while when you want to project the computer screen.
- Connect a USB cable directly to the USB connector of a computer. It will not work when connecting through a USB hub.

Termination of the USB display

When terminate the USB display, remove the USB cable directly.

Maintenance

This chapter describes the regular maintenance procedure of your projector to ensure its optimal operation status for long.

Regular maintenance

Status indicator

The status indicator shows status of projector protection function. Check STATUS and POWER indicator for good maintenance operation.



Note:

Unplug the AC power cord in case of any abnormality as it may lead to fire or electric shock.

The projector turns off, then the power indicator steady red and status indicator flashes red.

Your projector powers off automatically to protect components within it when it is overheated. The POWER indicator flashes red when your projector is cooling down. Press the STANDBY button to power your projector on again when it is cooled down to normal operation temperature.

The status indicator
flashing red

The power indicator
steady red

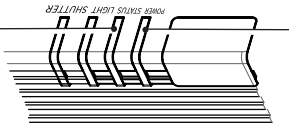

✓ Note:

The status indicator stops flashing when your projector's internal temperature cooled down to normal and it is powered on again.

Check the following:

- Is adequate clearance provided for your projector's ventilation? Check the installation status and any air outlet block.
- Is your projector installed at location close to outlet of air conditioning equipment? Keep your projector away from air outlet of air conditioning equipment.
- Is the filter in clean condition? Please clean the filter regularly.

Your projector powers off, the power indicator steady red and the status indicator flashing orange.

The STATUS indicator turns orange and your projector powers off to protect its internal components whenever an abnormality is detected. Unplug the AC power cord and connect again. Restart your projector and run checkup routine. If the problem persists, unplug the AC power cord and call your service center for checkup and maintenance.

The status indicator
flashing red

The power indicator
steady red

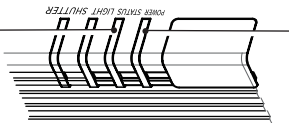

Regular maintenance

Clean your projector when it is contaminated by foreign matter or its display effects are getting worse.



Note:

Unplug the AC power cord before any cleaning operation.

Clean the lens

Wipe the lens with clean cloth dampened with non-abrasive camera lens cleaner or clean it with lens cleaning paper or air blower.

Do not over apply cleaner to the lens. Abrasive cleaner, solution, or other rough chemical may scratch the lens.

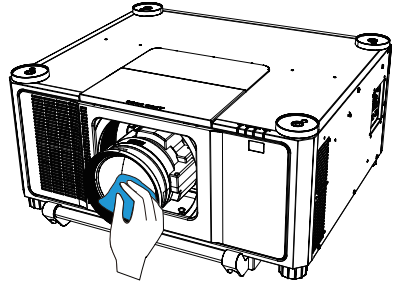

Clean casing of your projector

Wipe the casing surface with clean and soft cloth. Gently wipe the casing with clean and soft cloth dampened with small amount of neutral detergent to remove heavy dirt. Do not over apply cleaner to the casing. Abrasive cleaner, solution, or other rough chemical may scratch the casing surface.

Place your projector in proper container after use to protect it from dirt and dust and being scratched.

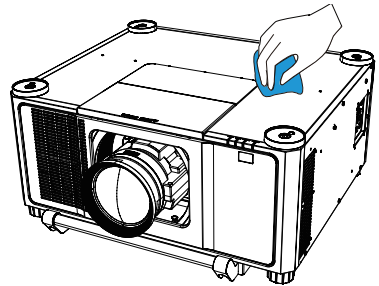

Note:

Do not insert any small object in the air outlet. It may fail your projector.

Appendix

Appendix

Troubleshooting

Check the following before calling your dealer or service center:

Troubleshooting	Solution
Power on failure	<ul style="list-style-type: none">– Plug the power cord of your projector in an AC socket.– Make sure the POWER light indicator turns red.– Restart your projector until the POWER light indicator turns red. It indicates your projector is ready for power on again.– Disable the Key Lock function of your projector.
Logo screen display failure	<ul style="list-style-type: none">– Make sure the Off and Countdown Off is selected in the Display function.
The Logo screen differs from the standard settings.	<ul style="list-style-type: none">– Make sure you did not select User or Off in the Logo Screen.
Input signal switch (or do not switch) automatically.	<ul style="list-style-type: none">– Make sure you have correctly set up the Input Search function at Auto setup menu.
Image looks fuzzy	<ul style="list-style-type: none">– Adjust the focus of the projection image.– Provide proper projection distance.– The projection lens requires cleaning.– Moving your projector from a colder environment to a hotter one may result in condensing on the lens. If this is the case, wait until the condensing water evaporated before powering on your projector.
Image mirror reflected / Image turns upside down	<ul style="list-style-type: none">– Check the Ceiling and Rear settings.– Check the Ceiling settings.
Image looks dim	<ul style="list-style-type: none">– Check the contrast and brightness settings.– Check for correct image mode settings– Check the laser control settings.
No image displays	<ul style="list-style-type: none">– Check for the connection between your projector and computer or image equipment.– Check for correct input signal from computer. Connection with certain notebook / computer may mandate changes to its display output settings. See the user manual included with the computer for details on settings.– It takes about 10 seconds for your projector to show the first image.– Check the mode of signal, color system, image system, or computer system.– Make sure the ambient temperature is within given range (41°F–95°F; 5°C–35°C).– Image does not display in BLANK mode. Press the BLANK button or other buttons on the remote controller.
Abnormal color	<ul style="list-style-type: none">– Check the mode of signal, color system, image system, or computer system.– Make sure Blackboard mode is not selected in Image mode.

Appendix

Some operations are invisible	– Check the display function.
Auto PC Adjusting function failure	– Check input signal. Auto PC Adjusting function is disable in 480p, 576p, 720p, 480i, 576i, 1080i or 1080p mode.
Settings do not save after power off	– Make sure you have selected Store after settings adjustment. Some settings do not keep without selecting with Store.
Power management failure	– In case of Freeze or Blank operation, the power management function does not work.
Auto Setting does not work	– Make sure it is not set to "Off" in each setup menu.
Image distorted or disappeared	– Check and revise the PC Adj. menu or Screen menu.
A password prompt displays after power on	– You have set up the Logo PIN Code lock function
Remote controller does not work	<ul style="list-style-type: none">– Check the battery.– Make sure there is no obstacles stand in between your projector and the remote controller.– Make sure the remote controller is not too far away from your projector. The maximum operation range is 5m.– Make sure the remote controller and your projector are paired with the same remote control code.– Disable the key lock of the remote controller in the Security menu.
Light indicator turns on or flashes	– Check status of your projector according to the light indicator status.
Exclamation mark displays	– Invalid operation, please operate your projector correctly.
Control panel does not work	– Disable the key lock on control panel function in the Security menu.
Cannot disable the Logo Select password, Key Lock, and PIN Code lock function	– Please call your dealer or contact the service center.

- Make sure your projector is correctly connected to external equipment.
- Make sure all devices have plugged in an AC power source and have been powered on.
- If your projector fails to project image of the connected computer, restart the computer.

















































Warning:

Your projector employs high voltage power for operation. Do not open its casing. If the problem persists, call your dealer or service center. Along with model number of your projector and a description to your problem. You will be advised on getting our services.

Appendix

Light indicator status

Check light indicator to learn status of your projector.

Light indicator				Status of your projector
POWER Green / Red / Orange	STATUS Red / Orange	LIGHT Green / Red / Orange	FILTER Green	
				Power Off (without AC power supply).
				Standby status. Press the Power button to turn it on. (Steady orange: Normal mode Flash once per time: Network mode Flash twice per time: ECO mode Flash three times per time: Warning up)
				Normal operating status.
				-Cooling as Normal standby process. -Cooling for Ready mode of power management. You may power on your projector after the projectio is fully cooled.
				Ready mode of power management. You may power on your projector by pressing any key.
				Lens calibration fail
				Abnormal temperature detected and get into cooling mode.
				Detects abnormal condition of Fan and get into standby mode after cooling down. (Flash once per time: Fan 1 fail, Flash twice per time: Fan 2 fail Flash three times per time: Fan 3 failFlash thirteen times per time: Fan 13 fail)
				Detects abnormal condition of color wheel.
				Detects abnormal condition of Light Source.
				Initialization..
				Enable the contrast optimization mode

 ...Green

 ...Red

 ...Orange

 ...Turns off

 ...Flashing green

 ...Flashing red

 ...Flashing orange

Appendix

Compatible computer screen

Your projector is designed to accept every analog computer signal below Dot Clock 160MHz and digital computer signal below Dot Clock 150MHz.

See table below for details on resolution and relevant frequency.

Input	Signal format	Resolution	Frequency (Hz)
PC	NTSC	720x480i	60
	PAL	720x576i	50
	480p	720x480	60
	576p	720x576	50
	720p	1280x720p	50
		1280x720p	60
	1080i	1920x1080i	50
		1920x1080i	60
	1080p	1920x1080p	50
		1920x1080p	60
	VGA	640x480	60
		640x480	67
		640x480	72
		640x480	75
	SVGA	640x480	85
		800x600	56
		800x600	60
		800x600	72
	800x600	800x600	75
		800x600	85
		800x600	85
	MAC 16	832x624	75
	XGA	1024x768	60
		1024x768	70
		1024x768	75
		1024x768	85
	XGA+	1152x864	70
		1152x864	75
	WXGA	1280x720	60
		1280x768	60
		1280x768	75
		1280x768	85
		1280x800	60
		1280x800	75
		1280x800	85
	1366x768	60	
	MSXGA	1280x960	60
	SXGA	1280x1024	60
		1280x1024	72
		1280x1024	75
		1280x1024	85
	SXGA+	1400x1050	60
1400x1050		75	
1440x900	1440x900	60	
	1440x900	60	
UXGA	1600x1200	60	
WSXGA+	1600x900	60	
	1680x1050	60	
WUXGA	1920x1080	60	
	1920x1200	60	



Input	Signal format	Resolution	Frequency (Hz)
HDMI	NTSC	720x480i	60
	PAL	720x576i	50
	480p	720x480	60
	576p	720x576	50
	720p	1280x720p	50
		1280x720p	60
	1080i	1920x1080i	50
		1920x1080i	60
	1080p	1920x1080p	24
		1920x1080p	50
		1920x1080p	60
	VGA	640x480	60
		640x480	67
		640x480	72
		640x480	75
		640x480	85
	SVGA	800x600	56
		800x600	60
		800x600	60
		800x600	72
		800x600	75
	800x600	800x600	75
		800x600	85
		800x600	85
	MAC 16	832x624	75
	XGA	1024x768	60
		1024x768	70
		1024x768	75
		1024x768	85
	XGA+	1152x864	70
		1152x864	75
	WXGA	1280x720	60
		1280x768	60
		1280x768	75
		1280x768	85
		1280x800	60
		1280x800	75
		1280x800	85
	1366x768	60	
	MSXGA	1280x960	60
	SXGA	1280x1024	60
		1280x1024	72
1280x1024		75	
1280x1024		85	
SXGA+	1400x1050	60	
	1400x1050	75	
1440x900	1440x900	60	
	1440x900	60	
UXGA	1600x1200	60	
WSXGA+	1600x900	60	
	1680x1050	60	
WUXGA	1920x1080	60	
	1920x1200	60	
4K	3840x2160	30	
	4096x2160	30	

✓ Note:

Changes to this manual may be made without notice.

Appendix

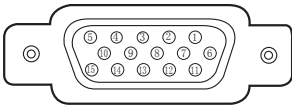
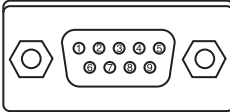
Terminal configuration

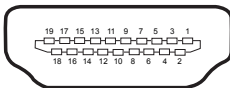
VGA IN / VGA OUT Terminal (D-sub 15)			
	1	Red (Input/output)	9 -----
	2	Green(Input/output)	10 Grounding (field synchronizing)
	3	Blue(Input/output)	11 Grounding
	4	-----	12 DDC data
	5	Grounding (line synchronizing)	13 Horizontal synchronizing (compound sync.)input/output
	6	Grounding(red)	14 Vertical synchronizing input/output
	7	Grounding(green)	15 DDC Clock
	8	Grounding(blue)	
SERIAL Terminal(D-SUB 9)			
	1	-----	6 -----
	2	RXD	7 -----
	3	TXD	8 -----
	4	-----	9 -----
	5	GND	
LAN Terminal			
	1	TX +	5 -----
	2	TX -	6 -----
	3	-----	7 RX +
	4	-----	8 RX -
HDBaseT Terminal			
	1	HDBT_P0	5 HDBT_P2
	2	HDBT_N0	6 HDBT_N2
	3	HDBT_P1	7 HDBT_P3
	4	HDBT_N1	8 HDBT_N3
HDMI Terminal (HDMI Type A 19)			
	1	TMDS Data2+	11 TMDS Clock Shield
	2	TMDS Date2 Shield	12 TMDS Clock-
	3	TMDS Date2-	13 CEC
	4	TMDS Date1+	14 Reserved (N.C. on device)
	5	TMDS Date1 Shield	15 SCL
	6	TMDS Date1-	16 SDA
	7	TMDS Date0+	17 DDC/CEC Ground
	8	TMDS Date0 Shield	18 +5V Power
	9	TMDS Date0-	19 Hot Plug Detect
	10	TMDS Clock+	

Appendix

Menu tree

Main menu	Sub-menu	Setting	Default value	Remarks
Display	Auto PC adj.			
	Fine sync	0-31		
	H Position	-5 - +5		
	V Position	-5 - +5		
	H Size	-15 - +15		The range of H Size differs from signals.
	Aspect	Normal 16:09, 16:10 4:3, 16:6	16:10	
	Project way	Front Rear Ceiling / Front Ceiling / Rear Auto ceiling / Front Auto ceiling / Rear	Front	
	Menu position	Upper Left, Upper Right Center Lower Left, Lower Right	Upper Left	
Background display	Black Blue	Blue		
System				
Color adjust	Image mode	Dynamic Standard Cinema Blackboard (Green) DICOM Colorboard User Image	Standard	
	Contrast	0-32	16	
	Brightness	0-32	16	
	Color temp	Hi-Brightness/High/ Normal/Mid/Low/User	Normal	
	Red	0-63	32	
	Green	0-63	32	
	Blue	0-63	32	
	Sharpness	0-15	8	
	Gamma	1.8/2.0/2.2/2.4/2.6	2.0	
Uniformity	0-8	8		

Appendix

Main menu	Sub-menu	Setting		Default value	Remarks	
Color adjust	Advance color adj.	Operation Select	Hue Luminance Saturation	Hue		
		Red	0-63	32		
		Yellow	0-63	32		
		Green	0-63	32		
		Cyan	0-63	32		
		Blue	0-63	32		
		Magenta	0-63	32		
Setting	Direct power on	On/Off		Off		
	Standby Mode	Normal/Eco mode		Eco		
	High land	On/Off		Off		
	Cooling fast	Normal/0 Sec/30 Sec		0 Sec		
	Key lock	Off/Projector/Remote controller		Off		
	Remote Controll	0-9		0		
	Contrast Optimization	On/Off		Off		
	Edge Blending	Edge Blending		On/Off	Off	HDMI input only
		Area setting	Boundary line	Off/Line/Grid	Off	
			Left	On/Off	Off	
			Top	On/Off	Off	
			Right	On/Off	Off	
			Bottom	On/Off	Off	
			Left Range	0-100%	20%	
			Top Range	0-100%	20%	
			Right Range	0-100%	20%	
			Bottom Range	0-100%	20%	
		White Balance	R Gain	0-64	32	
			G Gain	0-64	32	
			B Gain	0-64	32	
			R Offset	0-64	32	
G Offset	0-64		32			
B Offset	0-64		32			
Reset						

Appendix

Main menu	Sub-menu	Setting		Default value	Remarks	
Setting	Edge Blending	Image edge adj	Blending area	Left / Right / Top / Bottom / Center area	Left	
			Level	Level 0 /Level 1 /Level 2 / Level 3 /Level 4 /Level 5		
			Red			
			Green			
			Blue			
			Gain	0-5	2	
		Reset				
		EB Keystone	EB 4D keystone			
			Grid Image Tune			
			Reset			
		Advanced	H Total	1~4	1	
			V Total	1~3	1	
			H Position	1~4	1	
			V Position	1~3	1	
			H Range 1	0-100%	20%	
			H Range 2	0-100%	20%	
			H Range 3	0-100%	20%	
			V Range 1	0-100%	20%	
			V Range 2	0-100%	20%	
		Stage light control	Stage light control	On/Off	Off	
			Projector ID	ID 1 - 12	ID 1	
		HDMI Setup	Image	Auto / 64-940 / 0-1023	Auto	
			Volume	HDMI / Computer	HDMI	
		Timing switch	Timing Switch	On/Off	Off	
			Operation Time	Sunday /Monday / Tuesday /Wednesday / Thursday / Friday / Saturday		
	Timing Setting					

Appendix

Main menu	Sub-menu	Setting	Default value	Remarks	
Expand	Language	26 Languages	English		
	Auto Setup	Input Search	On/Off	On	
		Auto PC Adj.	On/Off	On	
	Keystone	Keystone	Store / Reset	Store	
		H/V Keystone			
		6-Corner correction			
		Curved correction			
	Logo	Reset value			
		Logo select	Default/User/ Off	Default	
		Capture			
		Logo PIN Code Lock	On/Off	Off	
	Security	Logo PIN Code Change			
		PIN code lock	On/Off	Off	
	PIN code change				
	Power management	Ready / Shut down / Off / Timer / Ready Countdown		Ready	
	Lens Adjust	Lens position	Auto / Position 1 / Position 2 /Position 3	Auto	
		Focus			
		Zoom			
		Lens shift			
		Lens center			
		Lens calibration			
	Test pattern	Off / Gray scale(1-4) / Color bar / Red / Green / Blue / Cross hatch / White / Black / Raster gray		Off	
	Network	Network setting	LAN		
			DHCP	On/Off	Off
			IP address	192.168.1.100	
			Subnet	255.255.255.0	
			Gateway	192.168.1.1	
DNS		192.168.1.1			
Network status		MAC address			
	IP address	192.168.1.100			
Factory default					

Appendix

Main menu	Sub-menu	Setting	Default value	Remarks
Memory Viewer	Set slide			
	Slide transition effect	Slide down / Slide right	Slide right	
	Sort order	Extend name order / Size order / Time order / Name order	Name order	
	Rotate	No rotate / 270° Degree / 180° Degree / 90° Degree	No rotate	
	Best fit	On/Off	Off	
	Repeat	On/Off	On	
	Apply			
Info.	Input			
	H-sync freq.			
	V-sync freq.			
	Light source counter			
	Power Management			
	Image mode			

Input	_____	VGA
	_____	HDMI 1
	_____	HDMI 2
	_____	HD-BaseT
	_____	SDI
	_____	DVI
	_____	Network
	_____	Memory Viewer
	_____	USB display

Appendix

Technical Specifications

Mechanical properties

Dimensions (W×H×D)	599mm x232.2mm x 493.8mm (without protrusions)
Net Weight	28.9Kg (without projection lens)
Adjustable foot	5°

LCD resolution

LCD system	1.0" TFT
LCD resolution	1920X1200

Optical elements

Image size (diagonal lines)	60"- 500"
Projection distance(with AH-AV21030 Lens)	Wide: 1.57m ~ 13.687m / Tele: 2.568m ~ 21.945m
Lens (AH-AV21030 Lens)	F = 1.8~2.24 / f =27.7~44.3mm; Zoom times: 1.62X
Aspect Ratio	16:10

Terminal

VGA IN	Mini D-sub 15 pin x1
USB connector	USB-A x1, USB-B x1
LAN	RJ45 x1, 100 Base-TX (100Mbps)/10 Base-T (10Mbps)
DVI	Digital (DVI-D) 24 pin x1
HDMI IN	HDMI x2
HDMI OUT	HDMI x1
AUDIO IN	3.5mm Mini Type Stereo x1
AUDIO OUT	3.5mm Mini Type Stereo x1
Wired remote control input terminal	Mini Jack, 3.5mm x1
Wired remote control output terminal	Mini Jack, 3.5mm x1
CONTROL terminal	D-sub 9 pin x1
HDBaseT	RJ45 x1 HDMI (Video, Audio), RS-232C, 100 Base-TX (100Mbps)/10 Base-T (10Mbps)
DMX512	S-terminal 9 pin x1

Power

Voltage and power consumption	AC 100–240 V, Max 11.9A, 50/60 Hz
-------------------------------	-----------------------------------

Operating Environment

Operating temperature	41°F-104°F (5°C-40°C)
Storage Temperature	14°F-122°F (-10°C-50°C)
High land	under 3650 m

Remote control

Battery	AA or LR6 1.5V ALKALINE TYPE x 2
Operating Range	16.4' (5 m)±30°
Dimensions	48mm (W) x 26mm (H) x 160mm (D)
Net Weight	67g (including batteries)

Accessories

Safety Guide	AC power cord (US Type x 1 / Euro Type x 1)
Quick Start Guide	HDMI cable
Remote controller	Power cord lock

- The aforesaid specification is subject to change without prior notice.
- Liquid crystal panel is made on the basis of high standard, where 99.99% of the pixels are effective. Due to the nature of the liquid crystal panel, a fraction of the pixels (0.01% or less) may be ineffective.

Appendix

Information of Optional Lens

Model#	AH-AV21030	AH-AV22060	AH-AV22070	AH-AV21020	AH-AV24010
Lens Type	Standard Lens	Short Lens	Short Lens	Short Lens	Long Lens
Zoom Ratio	1.62X Motorized zoom	1.23X Motorized zoom	1.34X Manual zoom	1.45X Motorized zoom	1.99X Manual zoom
F# (Wide-Tele)	1.80-2.24	2.0-2.5	1.7-2.37	2.2-2.6	2.2-2.7
f (mm)	27.7-44.3	13.3-18.6	24.4-48.6	49.7-99.8	76.6-116.5
Throw ratio (16:10)	1.24-2.01	0.79-1.11	1.46-2.95	2.99-5.93	4.59-7.02
Projection image size	60 - 500 inch	60 - 500 inch	60 - 500 inch	60 - 500 inch	60 - 500 inch

Appendix

Dimensions

Unit: mm

↘ Screw Holes for Ceiling Mount
Screw: M4
Depth: 8.0

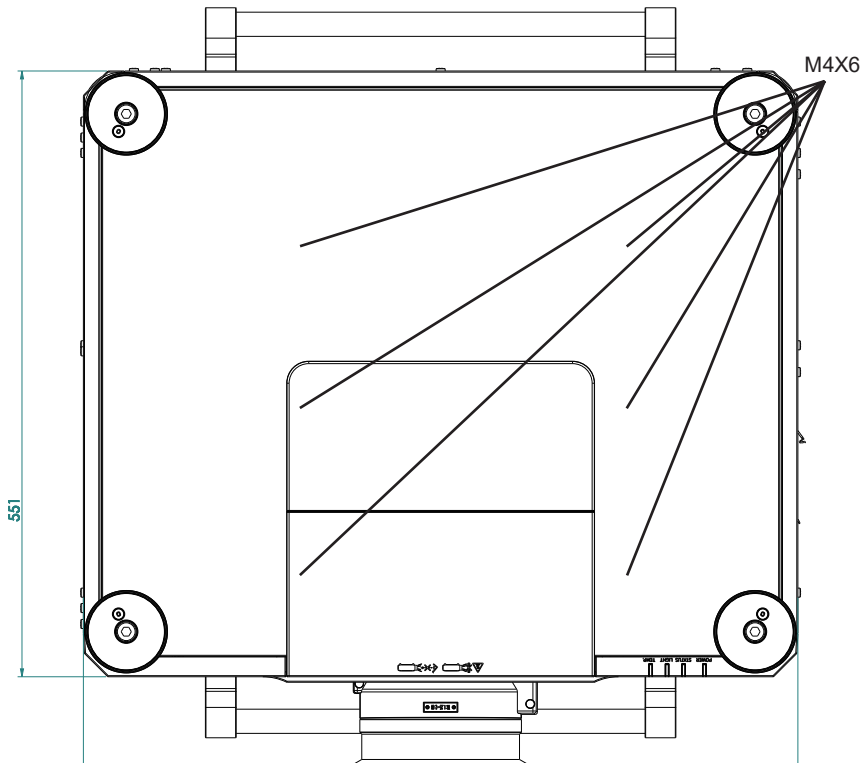
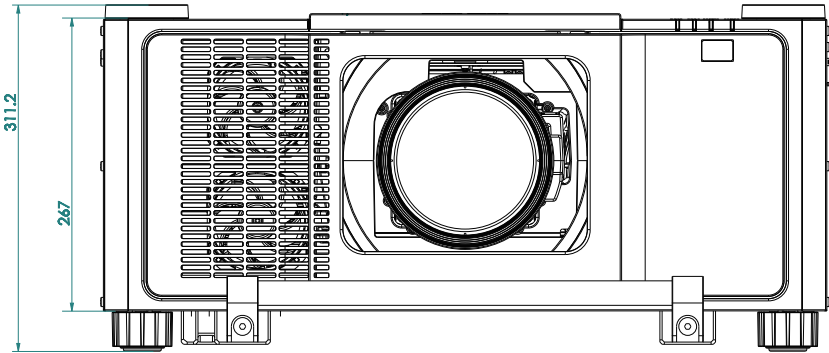

Appendix

PIN code memorandum

Write down the PIN code in the blank below and keep it, If you forgot or lost the number and unable to operate the projector, contact the service center.

Factory default PIN code 111*

PIN code lock

--	--	--

Factory default PIN code 111*

Logo PIN code Lock No.

--	--	--

*If this 3-digit number is changed,
the factory default number will be ineffective.

EIKI

U.S.A. / Canada

EIKI International, Inc.
22552 Avenida Empresa Rancho Santa
Margarita, CA 92688 U.S.A.
Tel: +1-800-242-3454
+1 949-742-6800
E-Mail: usa@eiki.com

China

EIKI (Shanghai) Co., Ltd.
LAKESIDE OASIS MIDDLE RING
BUSINESS CENTRE Block 1, Room 606,
1628, Jin Sha Jiang Road
Shanghai, 200333, CHINA
Tel: +86 21-3251-3993
Service Hot line: +86 21-3251-3995
Fax: +86 21-3251-3997
E-mail: info@eiki-china.com

South East Asia

EIKI Industrial (M) Sdn Bhd
No. 11, Nouvelle Industrial Park,
Lorong Teknologi B, Taman Sains
Selangor 1, Kota Damansara PJU5,
47810 Petaling Jaya,
Selangor Darul Ehsan, Malaysia
Tel: +60 3-6157-9330
Fax: +60 3-6157-1320
E-Mail: sales@eiki.my

Oceania

EIKI AUSTRALIA PTY LTD
Level 5, 11 Queens Road,
Melbourne, Victoria 3004, Australia
Tel: +61 03-8530-7048
Fax: +61 03-9820-5834
E-Mail: sales@eiki.net.au

Worldwide

EIKI JAPAN Co.,LTD
202 2-162-1 Higashisonoda,
Amagasaki-shi, Hyogo 6610953 Japan
Tel: +81 06-6499-8865
E-Mail: info@eiki-japan.info

World Wide Website <https://global.eiki.com>