



# Audipack®

It's great to have solutions...

## FACT SHEET

### 390771



**Quick Release**  
No tools required

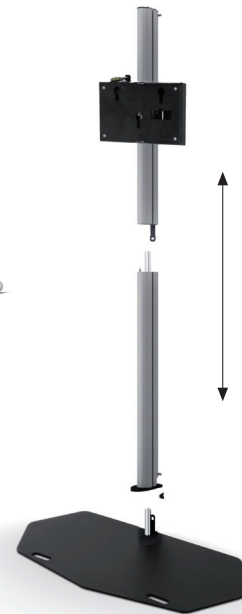

**1829 mm**

**Single column, dividable floor stand for flat panels up to 30 Kg. No tools needed for assembling. The perfect rental product.**

Single column flat panel floor stand for rental purposes. The quick release feature allows you to install the floor stand and screen on any location without tools.

The column has 3 separate cable passages allowing a separate passage of power, audio and data cables.

The presentation height of the flat panel is adjustable. This floor stand is suitable for flat panels with a maximum screen size of 55 inch, in landscape or portrait orientation.

- ▲ **No tools required for installation**
- ▲ **Integrated ruler for screen height positioning**
- ▲ **3 separate cable channels**
- ▲ **Suitable for all brands of flat panels**
- ▲ **Landscape and portrait orientation of the screen**

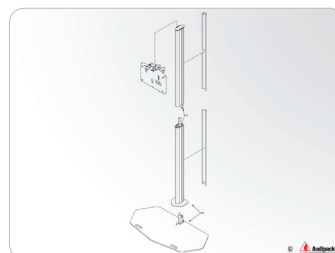



# Audipack®

It's great to have solutions...

# FACT SHEET

## 390771

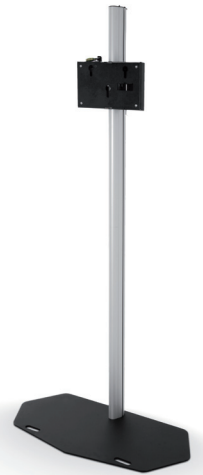
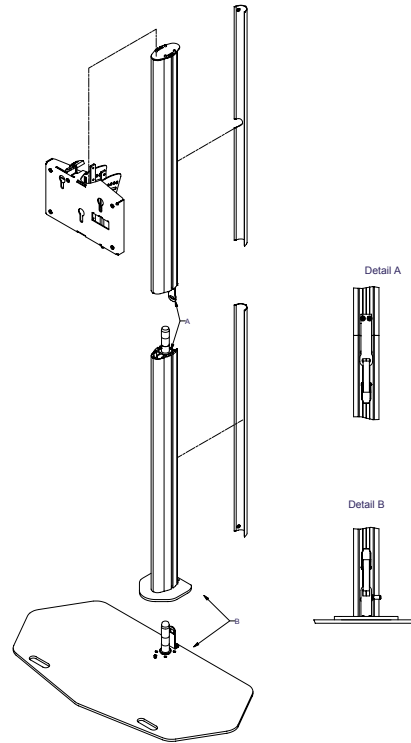
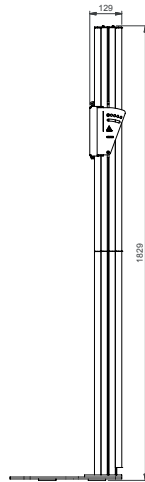
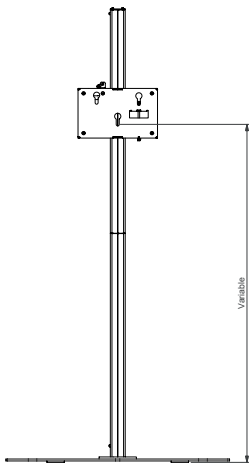
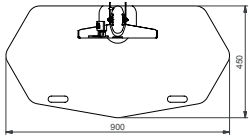

### Technical specifications

Dimensions in mm	W900 x D450 x H1829
Max. screen size	55 inch
Max. load	30 Kg
Mounting interface	L&S 3
Colour	Floor plate: Black, RAL 9005 Columns: Anodised aluminium
Weight	32 Kg
Screen orientation	Landscape or Portrait

### Optional

- Mounting bracket (required for screen installation)  
*universal models and brand related models available*
- Flightcase for safe transport of the floor stand and screen
- Laptop supports, 390729, 390730
- Mounting head for multiple screen installation, 390763
- Portrait/Landscape adapter, P3496
- Lock for protect the screen against theft, 230045, 230052