



Audipack®

It's great to have solutions...

FACT SHEET

390901



One of the best dividable floor stand for flat panels up to 60 Kg. No tools needed for assembling. The perfect rental product.

Flat panel floor stand for rental purposes. The quick release feature allows you to install the floor stand and screen on any location without tools.

The floor stand consists of a strong and solid vertical column, supplied with a wide access hatch on the back for power, audio and data cables.

The presentation height of the flat panel is adjustable. This floor stand is suitable for flat panels with a maximum screen size of 55 inch, in landscape or portrait orientation.

- ▲ **No tools required for installation**
- ▲ **Integrated ruler for screen height positioning**
- ▲ **Integrated yet easily accessible cable channel**
- ▲ **Suitable for all brands of flat panels**
- ▲ **Landscape and portrait orientation of the screen**





Audipack®

It's great to have solutions...

FACT SHEET

390901

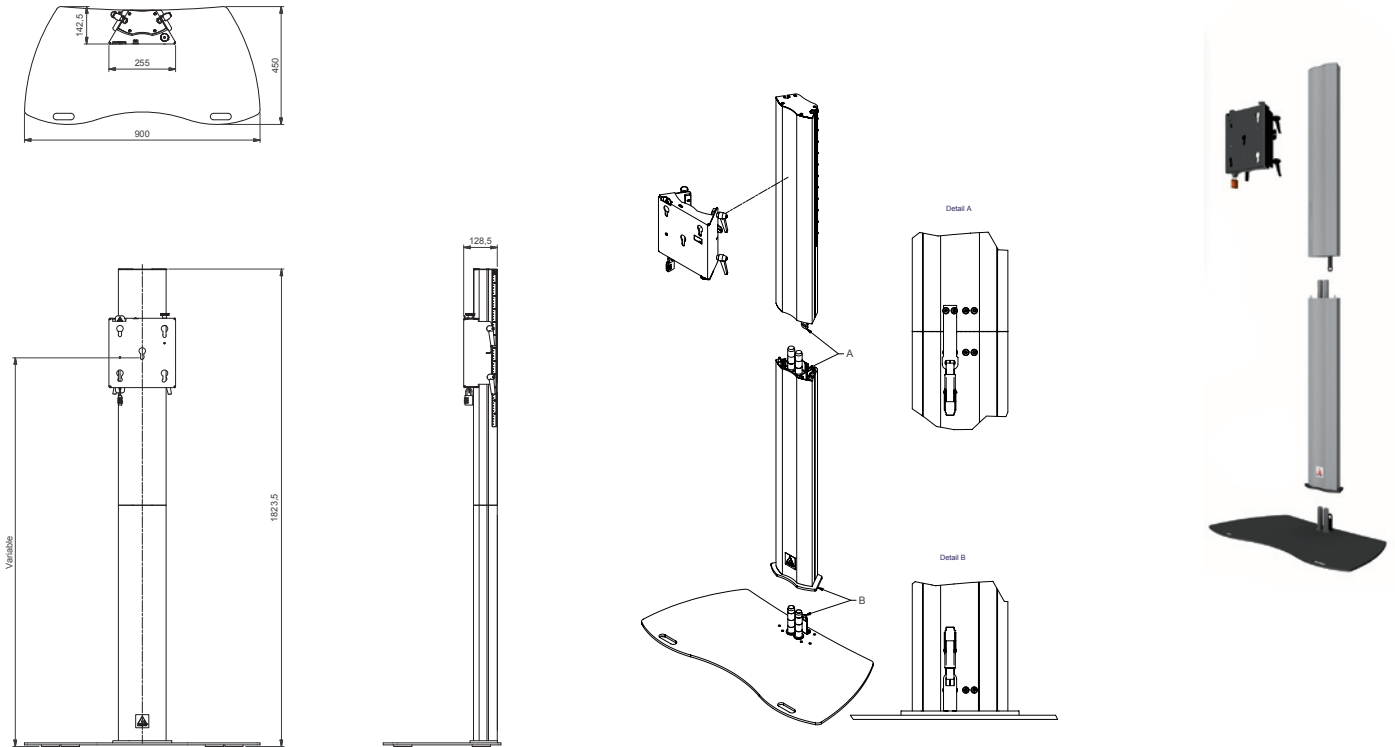

Technical specifications

Dimensions in mm	W900 x D450 x H1829
Max. screen size	55 inch
Max. load	60 Kg
Mounting interface	L&S 5
Colour	Floor plate: Black, RAL 9005 Column: Anodized aluminium
Weight	45 Kg
Screen orientation	Landscape or Portrait

Optional

- Mounting bracket (required for screen installation)
universal models and brand related models available
- Flightcase for safe transport of the floor stand and screen
- Laptop supports, 390915, 390916
- Laptop housings, 390937
- Equipment cabinets, EC-935, EC-936
- Mounting head for multiple screen installation, 390951
- Video conference mounting head, 390969, 390970
- Portrait/Landscape adapter, P3496
- Lock for protect the screen against theft, 230045, 230052