



**THE DISPLAY CHOICE
OF PROFESSIONALS™**

QX-32, QX-43 & QX-55 LED-Backlit Display

User Manual

www.agneovo.com

TABLE OF CONTENTS

SAFETY INFORMATION	1
Federal Communications Commission (FCC) Notice (U.S. Only).....	1
CE Declaration of Conformity.....	2
Polish Center for Testing and Certification Notice	3
Electric, Magnetic and Electromagnetic Fields (“EMF”).....	3
Information for U.K. only.....	4
North Europe (Nordic Countries) Information.....	5
End-of-Life Disposal.....	6
Waste Electrical and Electronic Equipment-WEEE.....	6
Turkey RoHS.....	7
Ukraine RoHS	7
PRECAUTIONS	8
Cautions When Setting Up.....	8
Cautions When Using.....	9
Cleaning and Maintenance.....	9
Notice for the LCD Display.....	10
CHAPTER 1: PRODUCT DESCRIPTION.....	11
1.1 Package Contents.....	11
1.2 Preparing for the Installation	12
1.3 Wall Mounting Installation.....	13
1.3.1 VESA Grid	14
1.4 Mounting in Portrait Position	14
1.5 LCD Display Overview	15
1.5.1 Control Panel.....	15
1.5.2 Input/Output Terminals	16
1.6 Remote Control	17
1.6.1 General Functions	17
1.6.2 Inserting the Batteries in the Remote Control	18
1.6.3 Handling the Remote Control	18
1.6.4 Operating Range of the Remote Control.....	18
CHAPTER 2: MAKING CONNECTIONS.....	19
2.1 Connecting the Power.....	19
2.2 Connecting a Computer	20
2.2.1 Using VGA Input	20
2.2.2 Using HDMI Input.....	20
2.2.3 Using DVI Input	21
2.2.4 Using DisplayPort (DP) Input	21
2.3 Connecting External Equipment (DVD / DVD-B).....	22
2.4 Connecting a USB Storage Device (for firmware upgrade).....	22
2.5 Connecting to Wired Network.....	23

TABLE OF CONTENTS

CHAPTER 3: USING THE LCD DISPLAY	24
3.1 Turning on the Power	24
3.2 Selecting the Input Source Signal	24
3.3 Adjusting the Volume	25
3.4 Changing the Picture Format	25
3.5 Choosing Your Preferred Picture Settings	26
3.6 Using Auto Adjustment Function	26
3.7 Using Multi-Window Mode	27
3.7.1 Multi-Window Options	27
3.7.2 PIP Swap	28
3.7.3 Setting the Sub-Source Signals	28
CHAPTER 4: ON SCREEN DISPLAY MENU	29
4.1 Using the OSD Menu	29
4.2 OSD Menu Tree	31
CHAPTER 5: ADJUSTING THE LCD DISPLAY	33
5.1 Brightness Menu	33
5.2 Adjust Screen Menu	35
5.3 Colour Setting Menu	36
5.4 OSD Setting Menu	39
5.5 All Reset Menu	40
5.6 Multi Window Menu	41
5.7 System 1 Menu	42
5.8 System 2 Menu	45
CHAPTER 6: APPENDIX	48
6.1 Warning Messages	48
6.2 Supported Resolution	49
6.3 Cleaning	50
6.4 Troubleshooting	51
6.5 Transporting the LCD Display	52
6.5.1 QX-32	52
6.5.2 QX-43 / QX-55	53
CHAPTER 7: SPECIFICATIONS	54
7.1 Display Specifications	54
7.2 Display Dimensions	56
7.2.1 QX-32 Dimensions	56
7.2.2 QX-43 Dimensions	56
7.2.3 QX-55 Dimensions	57

SAFETY INFORMATION

Federal Communications Commission (FCC) Notice (U.S. Only)



This equipment has been tested and found to comply with the limits for a Class B digital device, pursuant to part 15 of the FCC Rules. These limits are designed to provide reasonable protection against harmful interference in a residential installation. This equipment generates, uses and can radiate radio frequency energy and, if not installed and used in accordance with the instructions, may cause harmful interference to radio communications. However, there is no guarantee that interference will not occur in a particular installation. If this equipment does cause harmful interference to radio or television reception, which can be determined by turning the equipment off and on, the user is encouraged to try to correct the interference by one or more of the following measures:

- Reorient or relocate the receiving antenna.
- Increase the separation between the equipment and receiver.
- Connect the equipment into an outlet on a circuit different from that to which the receiver is connected.
- Consult the dealer or an experienced radio/TV technician for help.



Changes or modifications not expressly approved by the party responsible for compliance could void the user's authority to operate the equipment.

Use only an RF shielded cable that was supplied with the display when connecting this display to a computer device.

To prevent damage which may result in fire or shock hazard, do not expose this appliance to rain or excessive moisture.

THIS CLASS A DIGITAL APPARATUS MEETS ALL REQUIREMENTS OF THE CANADIAN INTERFERENCE-CAUSING EQUIPMENT REGULATIONS.



This device complies with Part 15 of the FCC Rules. Operation is subject to the following two conditions: (1) this device may not cause harmful interference, and (2) this device must accept any interference received, including interference that may cause undesired operation.

SAFETY INFORMATION

CE Declaration of Conformity

We declare under our responsibility that the product is in conformity with the following standards:

- EN60950-1:2006+A11:2009+A1:2010+A12:2011+A2:2013 (Safety requirement of Information Technology Equipment).
- EN55032:2012+AC:2013 (Radio Disturbance requirement of Information Technology Equipment).
- EN55024:2010 (Immunity requirement of Information Technology Equipment).
- EN61000-3-2-2014 (Limits for Harmonic Current Emission).
- EN61000-3-3:2013 (Limitation of Voltage Fluctuation and Flicker)
- EN 50581:2012 (Technical documentation for the assessment of electrical and electronic products with respect to the restriction of hazardous substances)
- EN 50564:2011 (Electrical and electronic household and office equipment — Measurement of low power consumption) following provisions of directives applicable.
- 2006/95/EC (Low Voltage Directive).
- 2004/108/EC (EMC Directive).
- 2009/125/EC (ErP, Energy-related Product Directive, EC No. 1275/2008 and 642/2009 Implementing)
- 2011/65/EU (RoHS Directive) and is produced by a manufacturing organization on ISO9000 level.

WARNING: This equipment is compliant with Class A of EN55032/CISPR 32. In a residential environment, this equipment may cause radio interference.

SAFETY INFORMATION

Polish Center for Testing and Certification Notice

The equipment should draw power from a socket with an attached protection circuit (a three-prong socket). All equipment that works together (computer, display, printer, and so on) should have the same power supply source.

The phasing conductor of the room's electrical installation should have a reserve short-circuit protection device in the form of a fuse with a nominal value no larger than 16 amperes (A).

To completely switch off the equipment, the power supply cable must be removed from the power supply socket, which should be located near the equipment and easily accessible.

A protection mark "B" confirms that the equipment is in compliance with the protection usage requirements of standards PN-93/T-42107 and PN-89/E-06251.

Wymagania Polskiego Centrum Badań i Certyfikacji

Urządzenie powinno być zasilane z gniazda z przyłączonym obwodem ochronnym (gniazdo z kolkiem). Współpracujące ze sobą urządzenia (komputer, monitor, drukarka) powinny być zasilane z tego samego źródła.

Instalacja elektryczna pomieszczenia powinna zawierać w przewodzie fazowym rezerwową ochronę przed zwarciami, w postaci bezpiecznika o wartości znamionowej nie większej niż 16A (amperów).

W celu całkowitego wyłączenia urządzenia z sieci zasilania, należy wyjąć wtyczkę kabla zasilającego z gniazdką, które powinno znajdować się w pobliżu urządzenia i być łatwo dostępne.

Znak bezpieczeństwa "B" potwierdza zgodność urządzenia z wymaganiami bezpieczeństwa użytkowania zawartymi w PN-93/T-42107 i PN-89/E-06251.

Pozostałe instrukcje bezpieczeństwa

- Nie należy używać wtyczek adapterowych lub usuwać kolka obwodu ochronnego z wtyczki. Jeżeli konieczne jest użycie przedłużacza to należy użyć przedłużacza 3-żyłowego z prawidłowo połączonym przewodem ochronnym.
- System komputerowy należy zabezpieczyć przed nagłymi, chwilowymi wzrostami lub spadkami napięcia, używając eliminatora przepięć, urządzenia dopasowującego lub bezzakłóceńowego źródła zasilania.
- Należy upewnić się, aby nic nie leżało na kablach systemu komputerowego, oraz aby kable nie były umieszczone w miejscu, gdzie można byłoby na nie nadeptywać lub potykać się o nie.
- Nie należy rozlewać napojów ani innych płynów na system komputerowy.
- Nie należy wpychać żadnych przedmiotów do otworów systemu komputerowego, gdyż może to spowodować pożar lub porażenie prądem, poprzez zwarcie elementów wewnętrznych.
- System komputerowy powinien znajdować się z dala od grzejników i źródeł ciepła. Ponadto, nie należy blokować otworów wentylacyjnych. Należy unikać kładzenia luźnych papierów pod komputer oraz umieszczania komputera w ciasnym miejscu bez możliwości cyrkulacji powietrza wokół niego.

Electric, Magnetic and Electromagnetic Fields ("EMF")

- We manufacture and sell many products targeted at consumers, which, like any electronic apparatus, in general have the ability to emit and receive electromagnetic signals.
- One of our leading Business Principles is to take all necessary health and safety measures for our products, to comply with all applicable legal requirements and to stay well within the EMF standards applicable at the time of producing the products.
- We are committed to develop, produce and market products that cause no adverse health effects.
- We confirm that if its products are handled properly for their intended use, they are safe to use according to scientific evidence available today.
- We play an active role in the development of international EMF and safety standards, enabling us to anticipate further developments in standardization for early integration in its products.

SAFETY INFORMATION

Information for U.K. only

WARNING - THIS APPLIANCE MUST BE EARTHED.

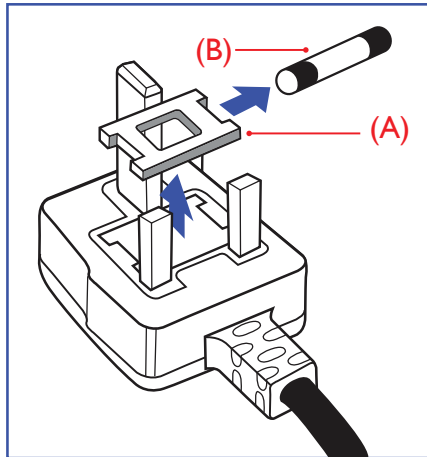

Important:

This apparatus is supplied with an approved moulded 13A plug. To change a fuse in this type of plug proceed as follows:

- 1 Remove fuse cover and fuse.
- 2 Fit new fuse which should be a BS 1362 5A, A.S.T.A. or BSI approved type.
- 3 Refit the fuse cover.

If the fitted plug is not suitable for your socket outlets, it should be cut off and an appropriate 3-pin plug fitted in its place.

If the mains plug contains a fuse, this should have a value of 5A. If a plug without a fuse is used, the fuse at the distribution board should not be greater than 5A.



Note:

The severed plug must be destroyed to avoid a possible shock hazard should it be inserted into a 13A socket elsewhere.

SAFETY INFORMATION

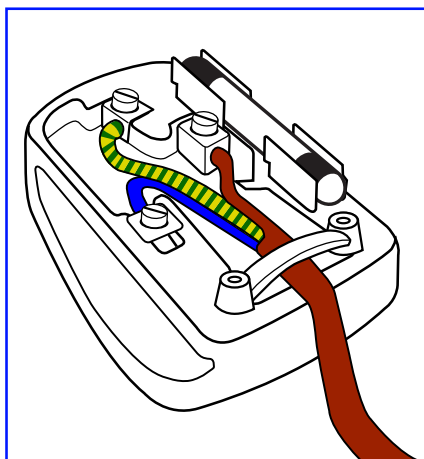

How to connect a plug

The wires in the mains lead are coloured in accordance with the following code:

BLUE - "NEUTRAL" ("N")

BROWN - "LIVE" ("L")

GREEN & YELLOW - "EARTH" ("E")

- The GREEN & YELLOW wire must be connected to the terminal in the plug which is marked with the letter "E" or by the Earth symbol or coloured GREEN or GREEN & YELLOW.
- The BLUE wire must be connected to the terminal which is marked with the letter "N" or coloured BLACK.
- The BROWN wire must be connected to the terminal which marked with the letter "L" or coloured RED.

Before replacing the plug cover, make certain that the cord grip is clamped over the sheath of the lead - not simply over the three wires.

North Europe (Nordic Countries) Information

Placering/Ventilation

WARNING: FÖRSÄKRA DIG OM ATT HUVUDBRYTARE OCH UTTAG ÄR LÄTÅTKOMLIGA, NÄR DU STÄLLER DIN UTRUSTNING PÅPLATS.

Placering/Ventilation

ADVARSEL: SØRG VED PLACERINGEN FOR, AT NETLEDNINGENS STIK OG STIKKONTAKT ER NEMT TILGÆNGLIGE.

Paikka/Ilmankierto

VAROITUS: SIJOITA LAITE SITEN, ETTÄ VERKKOJOHTO VOIDAAN TARVITTAESSA HELPOSTI IRROTTAA PISTORASIESTA.

Plassering/Ventilasjon

ADVARSEL: NÅR DETTE UTSTYRET PLASSERES, MÅ DU PASSE PÅ AT KONTAKTENE FOR STØMTILFØRSEL ER LETTE Å NÅ.

SAFETY INFORMATION

End-of-Life Disposal

Your new Public Information Display contains materials that can be recycled and reused. Specialized companies can recycle your product to increase the amount of reusable materials and to minimize the amount to be disposed of.

Please find out about the local regulations on how to dispose of your old display from your local dealer.

(For customers in Canada and U.S.A.)

This product may contain lead and/or mercury. Dispose of in accordance to local-state and federal regulations. For additional information on recycling contact www.eia.org (Consumer Education Initiative).

Waste Electrical and Electronic Equipment-WEEE

Attention users in European Union private households

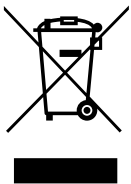

This marking on the product or on its packaging illustrates that, under European Directive 2012/19/EU governing used electrical and electronic appliances, this product may not be disposed of with normal household waste. You are responsible for disposal of this equipment through a designated waste electrical and electronic equipment collection. To determine the locations for dropping off such waste electrical and electronic, contact your local government office, the waste disposal organization that serves your household or the store at which you purchased the product.

Attention users in United States:

Please dispose of according to all Local, State and Federal Laws. For the disposal or recycling information, contact: www.mygreenelectronics.com or www.eiae.org.

End of Life Directives-Recycling



Your new Public Information Display contains several materials that can be recycled for new users.

Please dispose of according to all Local, State, and Federal laws.

Restriction on Hazardous Substances statement (India)

This product complies with the "India E-waste Rule 2011" and prohibits use of lead, mercury, hexavalent chromium, polybrominated biphenyls or polybrominated diphenyl ethers in concentrations exceeding 0.1 weight % and 0.01 weight % for cadmium, except for the exemptions set in Schedule 2 of the Rule.

E-Waste Declaration for India



This symbol on the product or on its packaging indicates that this product must not be disposed of with your other household waste. Instead it is your responsibility to dispose of your waste equipment by handing it over to a designated collection point for the recycling of waste electrical and electronic equipment. The separate collection and recycling of your waste equipment at the time of disposal will help to conserve natural resources and ensure that it is recycled in a manner that protects human health and the environment.

SAFETY INFORMATION

Batteries



For EU: The crossed-out wheeled bin implies that used batteries should not be put to the general household waste! There is a separate collection system for used batteries, to allow proper treatment and recycling in accordance with legislation.

Please contact your local authority for details on the collection and recycling schemes.

For Switzerland: The used battery is to be returned to the selling point.

For other non-EU countries: Please contact your local authority for correct method of disposal of the used battery.

According to EU directive 2006/66/EC, the battery can't be disposed improperly. The battery shall be separated to collect by local service.

Turkey RoHS

Türkiye Cumhuriyeti: EEE Yönetmeliğine Uygundur.

Ukraine RoHS

Обладнання відповідає вимогам Технічного регламенту щодо обмеження використання деяких небезпечних речовин в електричному та електронному обладнанні, затвердженого постановою Кабінету Міністрів України від 3 грудня 2008 № 1057.

PRECAUTIONS

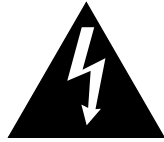

Symbols used in this manual

	This icon indicates the existence of a potential hazard that could result in personal injury or damage to the product.
	This icon indicates important operating and servicing information.

Notice

- Read this User Manual carefully before using the LCD display and keep it for future reference.
- The product specifications and other information provided in this User Manual are for reference only. All information is subject to change without notice. Updated content can be downloaded from our web site at <http://www.agneovo.com>.
- To register online, go to <http://www.agneovo.com>.
- To protect your rights as a consumer, do not remove any stickers from the LCD display. Doing so may affect the determination of the warranty period.

Cautions When Setting Up

- Do not place the LCD display near heat sources, such as a heater, exhaust vent, or in direct sunlight.
- Do not cover or block the ventilation holes in the housing.
- Place the LCD display on a stable area. Do not place the LCD display where it may subject to vibration or shock.
- Place the LCD display in a well-ventilated area.
- Do not place the LCD display outdoors.
- To avoid the risk of shock or permanent damage to the set, do not expose the display to dust, rain, water or an excessively moist environment.
- Do not spill liquid or insert sharp objects into the LCD display through the ventilation holes. Doing so may cause accidental fire, electric shock or damage the LCD display.

PRECAUTIONS

Cautions When Using

- Use only the power cord supplied with the LCD display.
- The power outlet should be installed near the LCD display and be easily accessible.
- If an extension cord is used with the LCD display, ensure that the total current consumption plugged into the power outlet does not exceed the ampere rating.
- Do not allow anything to rest on the power cord. Do not place the LCD display where the power cord may be stepped on.
- If the LCD display will not be used for an indefinite period of time, unplug the power cord from the power outlet.
- To disconnect the power cord, grasp and pull by the plug head. Do not tug on the cord; doing so may cause fire or electric shock.
- Do not unplug or touch the power cord with wet hands.
- When turning off the display by detaching the power cord, wait 6 seconds before re-attaching the power cord for normal operation.
- Do not knock or drop the display during operation or transportation.

Cleaning and Maintenance

- To protect your display from possible damage, do not put excessive pressure on the LCD panel. When moving your display, grasp the frame to lift; do not lift the display by placing your hand or fingers on the LCD panel.
- Unplug the display if you need to clean it with a slightly damp cloth. The screen may be wiped with a dry cloth when the power is off. However, never use organic solvent, such as, alcohol, or ammonia-based liquids to clean your display.
- If your display becomes wet, wipe it with dry cloth as soon as possible.
- If a foreign substance or water gets in your display, turn the power off immediately and disconnect the power cord. Then remove the foreign substance or water, and send the unit to the maintenance center.
- In order to maintain the best performance of your display and ensure a longer lifetime, we strongly recommend using the display in a location that falls within the following temperature and humidity ranges.
 - ◆ Temperature: 0-40°C (32-104°F)
 - ◆ Humidity: 5%~95% RH



Warning:



Unplug the power cord from the power outlet and refer to qualified service

personnel under the following conditions:

- ◆ When the power cord is damaged.
- ◆ If the LCD display has been dropped or the housing has been damaged.
- ◆ If the LCD display emits smoke or a distinct odor.

PRECAUTIONS

Notice for the LCD Display

- In order to maintain the stable luminous performance, it is recommended to use low brightness setting.
- Due to the lifespan of the lamp, it is normal that the brightness quality of the LCD display may decrease with time.
- When static images are displayed for long periods of time, the image may cause an imprint on the LCD display. This is called image retention or burn-in.
 - ◆ To prevent image retention, do any of the following:
 - Set the LCD display to turn off after a few minutes of being idle.
 - Use a screen saver that has moving graphics or a blank white image.
 - Execute the ANTI-BURN-IN function of the LCD display. Refer to “ANTI-BURN-IN” on page 45.
 - Switch desktop backgrounds regularly.
 - Adjust the LCD display to low brightness settings.
 - Turn off the LCD display when the system is not in use.
 - ◆ Things to do when the LCD display shows image retention:
 - Turn off the LCD display for extended periods of time. It can be several hours or several days.
 - Use a screen saver and run it for extended periods of time.
 - Use a black and white image and run it for extended periods of time.
- There are millions of micro transistors inside the LCD display. It is normal for a few transistors to be damaged and to produce spots. This is acceptable and is not considered a failure.
- **IMPORTANT:** Always activate a moving screen saver program when you leave your display unattended. Always activate a periodic screen refresh application if the unit will display unchanging static content. Uninterrupted display of still or static images over an extended period may cause “burn in”, also known as “after-imaging” or “ghost imaging”, on your screen. This is a well-known phenomenon in LCD panel technology. In most cases, the “burned in” or “after-imaging” or “ghost imaging” will disappear gradually over a period of time after the power has been switched off.
- **WARNING:** Severe “burn-in” or “after-image” or “ghost image” symptoms will not disappear and cannot be repaired. This is also not covered under the terms of your warranty.

CHAPTER 1: PRODUCT DESCRIPTION

1.1 Package Contents

When unpacking, check if the following items are included in the package. If any of them is missing or damaged, contact your dealer.

LCD Display



Quick start guide

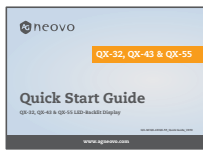

Remote control

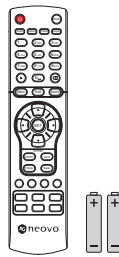

Power cord

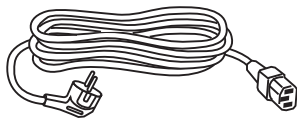

HDMI cable

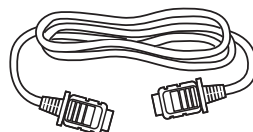

Note:

- ◆ Remote control is shipped with the supplied AAA batteries.
- ◆ For all other regions, apply a power cord that conforms to the AC voltage of the power socket and has been approved by and complies with the safety regulations of the particular country.
- ◆ You might like to save the package box and packing material for shipping the display.
- ◆ The pictures are for reference only. Actual items may vary upon shipment.

PRODUCT DESCRIPTION

1.2 Preparing for the Installation

- Due to the high power consumption, always use the plug exclusively designed for this product. If an extended line is required, please consult your service agent.
- The product should be installed on a flat surface to avoid tipping. The distance between the back of the product and the wall should be maintained for proper ventilation. Avoid installing the product in the kitchen, bathroom or any other places with high humidity so as not to shorten the service life of the electronic components.
- The product can normally operate only under 5000m in altitude. In installations at altitudes above 3000m, some abnormalities may be experienced.

Caution:

- ◆ Do not press too hard on the LCD panel or edge of the frame, as this may cause the device to malfunction.
- ◆ During unpacking, make sure to hold the carrying handles to remove the device from its packaging.

PRODUCT DESCRIPTION

1.3 Wall Mounting Installation

To mount this display to a wall, you will have to obtain a standard wall-mounting kit (commercially available). We recommend using a mounting interface that complies with TUV-GS and/or UL1678 standard in North America.

To wall-mount the LCD display, screw the mounting bracket to the VESA holes at the rear of the LCD display.

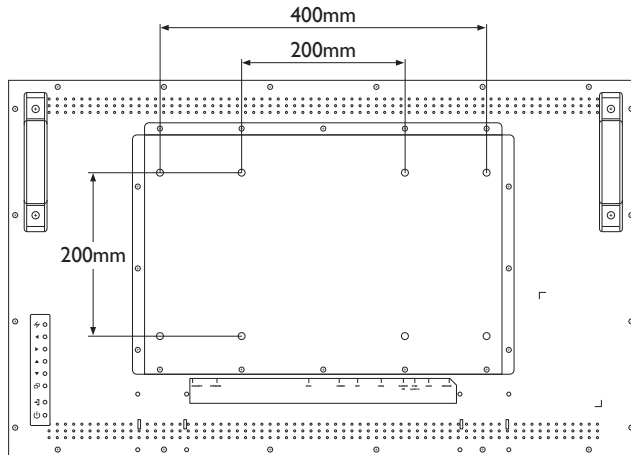

QX-32

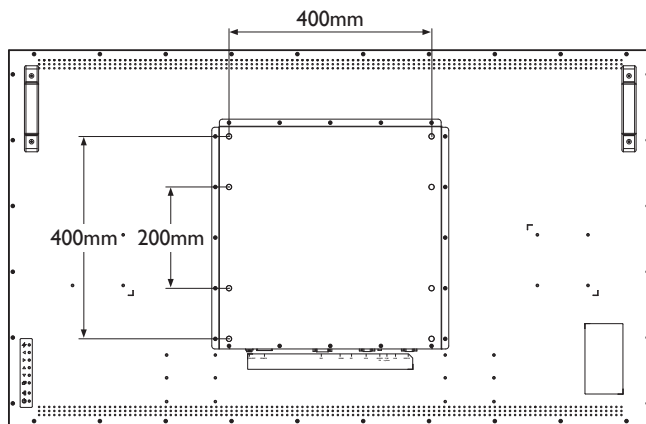

QX-43 / QX-55

Note:

- ◆ Avoid the wall-mounting kit to block the ventilation holes on the back of the display.
- ◆ Secure the LCD display on a solid wall strong enough to bear its weight.
- ◆ Lay a protective sheet on a table, which was wrapped around the display when it was packaged, beneath the screen surface so as not to scratch the screen face.
- ◆ Ensure you have all accessories for mounting this display (wall mount, ceiling mount, table stand, etc).
- ◆ Follow the instructions that come with the base mounting kit. Failure to follow correct mounting procedures could result in damage to the equipment or injury to the user or installer. Product warranty does not cover damage caused by improper installation.

PRODUCT DESCRIPTION

1.3.1 VESA Grid

Model Name	VESA Grid
QX-32	200x200 / 400x200
QX-43	400x400 / 400x200
QX-55	400x400 / 400x200

Caution:

To prevent the display from falling:

- ◆ For wall or ceiling installation, we recommend installing the display with metal brackets which are commercially available. For detailed installation instructions, refer to the guide received with the respective bracket.
- ◆ To lessen the probability of injury and damage resulting from fall of the display in case of earthquake or other natural disaster, be sure to consult the bracket manufacturer for installation location.

Note:

- ◆ For the wall-mounting kit, use M6 mounting screws (having a length 10 mm longer than the thickness of the mounting bracket) and tighten them securely.
- ◆ Unit weight is 15.7 kg (QX-32), 27.0 kg (QX-43), or 39.1 kg (QX-55). The equipment and its associated mounting means still remain secure during the test. For use only with UL Listed Wall Mount Bracket with minimum weight/load: 22 kg (QX-32), 37 kg (QX-43), or 51 kg (QX-55).

1.4 Mounting in Portrait Position

This display can be installed in portrait position.

- 1 Remove the table stand, if attached.
- 2 Rotate 90 degrees counter-clockwise.

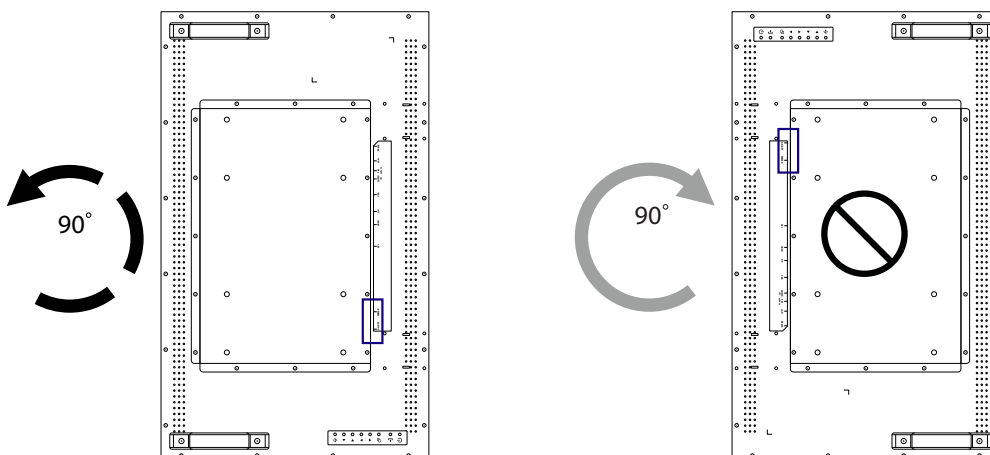

PRODUCT DESCRIPTION

1.5 LCD Display Overview

1.5.1 Control Panel

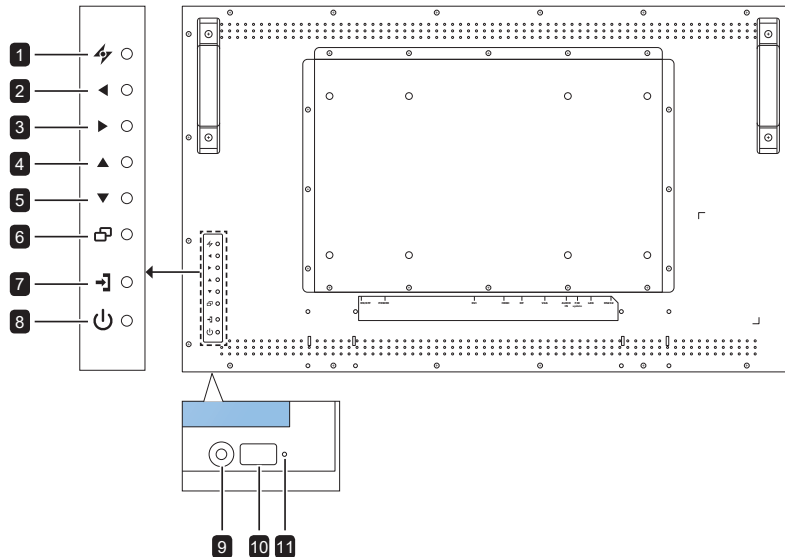

1 [⚡] AUTO

- For VGA input signal source, performs auto adjustment.
- Closes the OSD menu or exits a submenu while OSD menu is on.

2 [◀] LEFT

- Increases the adjustment or selects a setting while OSD menu is on.
- Increases the audio output level while OSD menu is off.

3 [▶] RIGHT

- Decreases the adjustment or selects the setting while OSD menu is on.
- Decreases the audio output level while OSD menu is off.

4 [▲] UP

- Press to select PIP or PBP (without pop up message).
- During OSD menu selection, press to move up a menu or submenu.

5 [▼] DOWN: Hotkey: Aspect Ratio

- When PIP is ON: SWAP the PIP main and sub picture (without pop up message).
- During OSD menu selection, press to move down a menu or submenu.

6 [☰] MENU

- Activates the OSD menu when OSD menu is off.
- Selects items or accepts the settings made in the OSD menu.

7 [↔] SOURCE

- Chooses the input source.

8 [⏻] Power

Turns the display on or off.

9 AUTO BRIGHTNESS (Light sensor)

Detects ambient lighting conditions and automatically adjusts the brightness levels. Refer to "AUTO BRIGHTNESS" on page 34 for more information.

10 IR sensor

Receives the signal from the remote control.

11 LED indicator

Displays the status of the IR sensor.

- Blue: The display's power is on.
- Amber: The display is in Stand-by mode.
- Off: The display's power is off.

PRODUCT DESCRIPTION

1.5.2 Input/Output Terminals

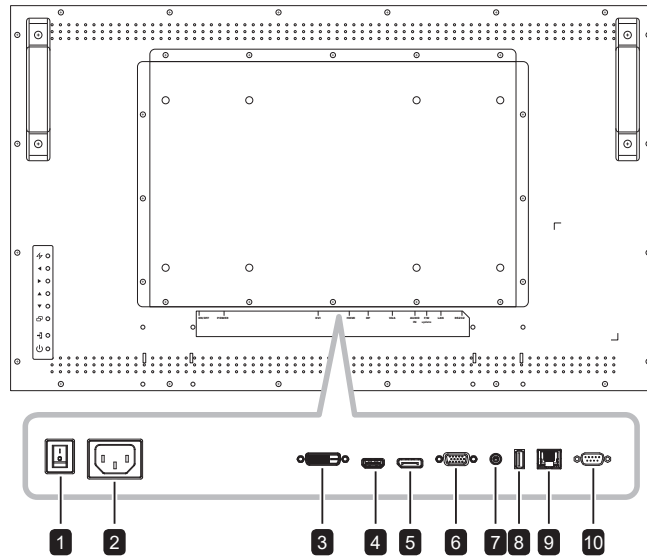

1 Main power switch

Switches the main power on or off.

2 AC IN

Connects with the supplied power cord.

3 DVI

Connects with the digital video output of a computer, and other applicable devices.

4 HDMI

Connects with devices supporting audio/ video data using the HDMI interface.

5 DisplayPort

Connects with devices supporting audio/ video data using the DisplayPort interface.

6 VGA

Connects with the analog video output (VGA) of a computer.

7 Audio in

Connects with the audio out connector of a video source such as a computer, VCR, or DVD player when the display is connected to the source via the VGA or DVI connector.

8 USB

Connects a USB compatible storage device for firmware upgrade.

9 RJ-45

Provides LAN control function for the use of remote control signal from the control center.

10 RS232 in

Connects with the serial IO connector of another device.

PRODUCT DESCRIPTION

1.6 Remote Control

1.6.1 General Functions

- 1 [Power]**
Turns the display on or off.
- 2 [Auto]**
For VGA input signal source, performs auto adjustment.
- 3 [Aspect]**
Adjusts the aspect ratio of the display.
- 4 [Numbers]**
Enters numbers for network settings.
- 5 [Menu]**
Displays the OSD menu. Please refer to page 31.
- 6 [Exit]**
Exits the current menu.
- 7 [Mute]**
Turns the mute function on or off.
- 8 [P.Mode]**
Chooses the picture mode.
- 9 [Display]**
Displays briefly the currently selected input source.
- 10 [Source]**
Switches the video input source. Use the [▲] [▼] button to select [VGA], [DVI], [HDMI], or [DP] and press the [SET] button to confirm the selection.
- 11 [SET]**
Chooses items or accepts the settings made in the OSD menu.
- 12 [▲] / [▼] / [◀] / [▶] Navigation buttons**
Navigates through menus, selects items, and adjusts values.
- 13 [PIP/PBP]**
 - [ON/OFF]: Turns the multi-window mode on or off.
 - [Input]: For PIP mode, selects the input signal for the sub source.
 - [Change]: Chooses the multi-window mode.
 - [Swap]: Swaps the main source and sub source signals.

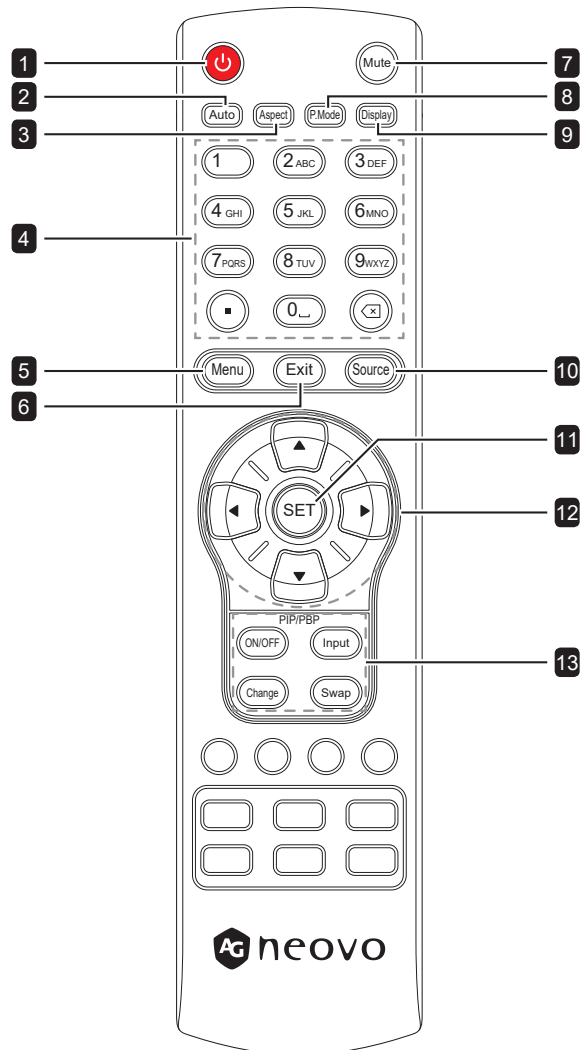

PRODUCT DESCRIPTION

1.6.2 Inserting the Batteries in the Remote Control

The remote control is powered by two 1.5V AAA batteries.

To install or replace batteries:

- 1 Open the remote control battery compartment cover.
- 2 Align the batteries according to the (+) and (-) indications inside the battery compartment.
- 3 Replace the cover.

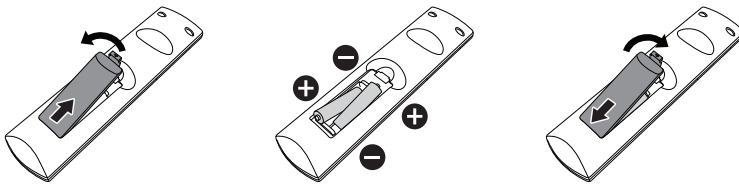

1.6.3 Handling the Remote Control

- Do not subject to strong shock.
- Do not allow water or other liquid to splash the remote control. If the remote control gets wet, wipe it dry immediately.
- Avoid exposure to heat and steam.
- Other than to install the batteries, do not open the remote control.

1.6.4 Operating Range of the Remote Control

Point the top of the remote control toward the display's remote control sensor (front side) when pressing a button.

Use the remote control within the range which is shown in the following table.

Operation Angle	RC operational distance
$\theta = 0^\circ$ (for H & V)	$\geq 15\text{m}$ (control from the front)
$\theta = 20^\circ$ (for H & V)	$\geq 10\text{m}$ (control from the front)
$\theta = 45^\circ$ (for H only)	$\geq 4\text{m}$ (control from the front)

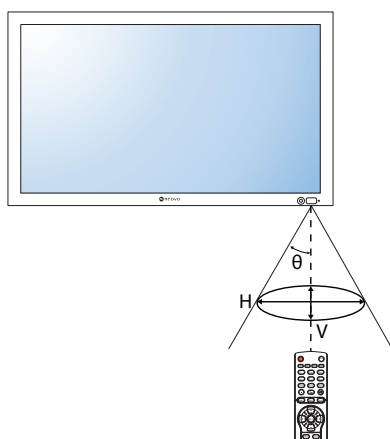

Caution:

The incorrect use of batteries can result in leaks or bursting. Be sure to follow these instructions:

- ◆ Place “AAA” batteries matching the (+) and (-) signs on each battery to the (+) and (-) signs of the battery compartment.
- ◆ Do not mix battery types.
- ◆ Do not combine new batteries with used ones. It causes shorter life or leakage of batteries.
- ◆ Remove the dead batteries immediately to prevent them from liquid leaking in the battery compartment. Don't touch exposed battery acid, as it can damage your skin.

Note:

- ◆ If you do not intend to use the remote control for a long period, remove the batteries.
- ◆ The remote control may not function properly when the remote control sensor on this display is under direct sunlight or strong illumination, or when there is an obstacle in the path of signal transmission.

CHAPTER 2: MAKING CONNECTIONS

2.1 Connecting the Power

- 1 Connect one end of the power cord to the AC IN connector at the rear of the LCD display.
- 2 Connect the other end of the power cord to a power outlet or a power supply.
- 3 Set the **Main Power** switch to ON.

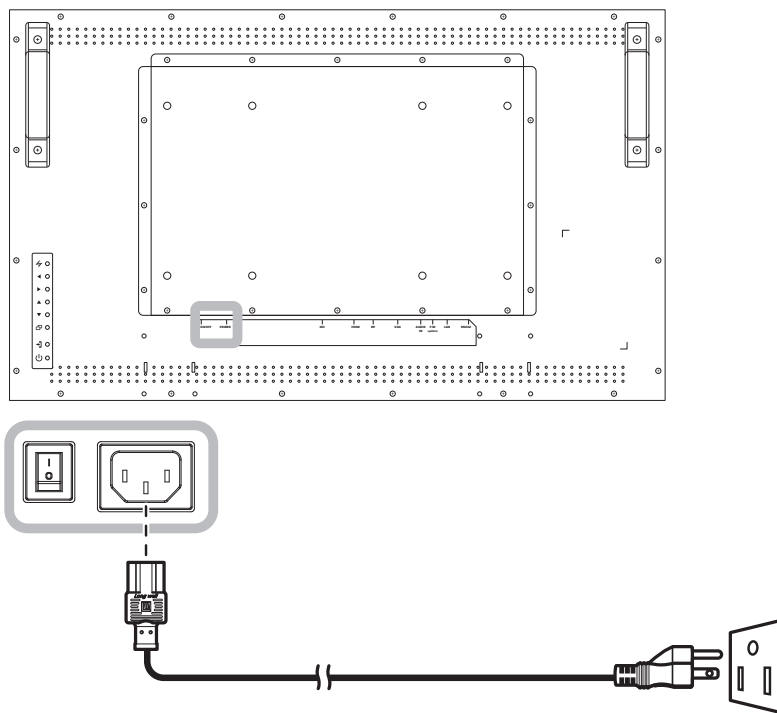

Caution:

- ◆ Make sure that the LCD display is not connected to the power outlet before making any connections. Connecting cables while the power is ON may cause electric shock or personal injury.
- ◆ When unplugging the power cord, hold the power cord by the plug head. Never pull by the cord.
- ◆ Loose connections may cause noise. Do not plug and unplug the power cord repeatedly in a short period of time.
- ◆ When disconnecting the AC power cord, be sure to first disconnect the plug from the outlet socket.

Note:

- ◆ The supplied power cord varies depending on the country where you purchased this LCD display. For all cases, use a power cord that matches the AC voltage of the power outlet and has been approved by and complies with the safety standard of your country.

MAKING CONNECTIONS

2.2 Connecting a Computer

2.2.1 Using VGA Input

- 1 Connect one end of a VGA cable to the VGA connector of the LCD display and the other end of a VGA cable to the VGA OUT (D-Sub) connector of the computer.
- 2 For audio input, connect one end of an audio cable to the AUDIO IN connector of the LCD display and the other end of an audio cable to the AUDIO OUT connector of the computer.
- 3 Press the **Source** button on the remote control and choose **VGA** as an input source.
- 4 Press the **Menu** button to display the OSD menu and choose **SYSTEM 1 > AUDIO IN** to set the audio input source to **LINE IN**.

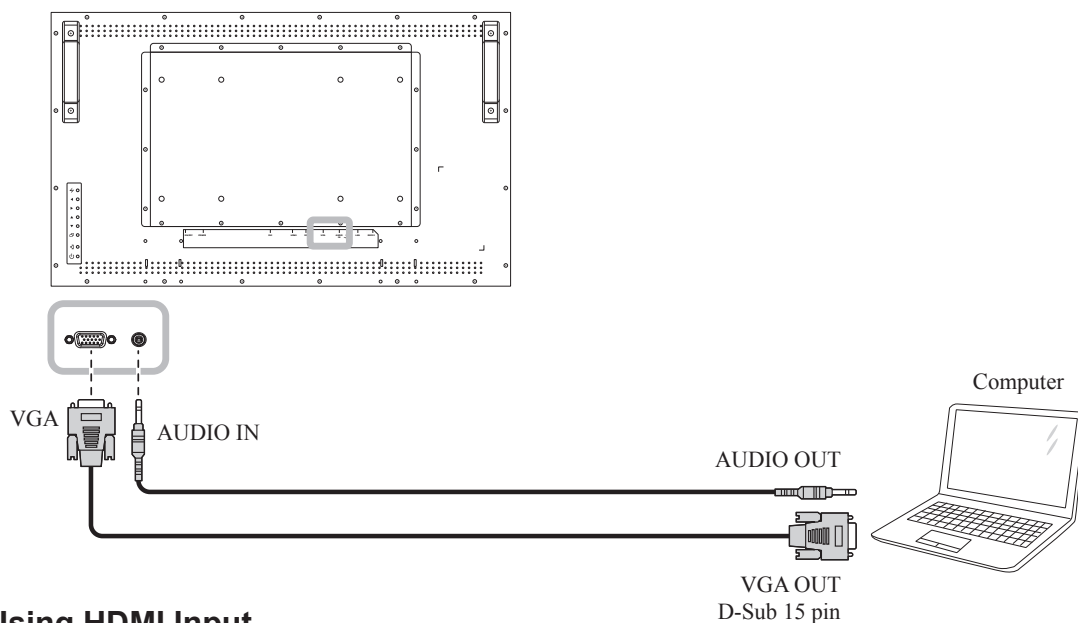

2.2.2 Using HDMI Input

- 1 Connect one end of an HDMI cable to the HDMI connector of the LCD display and the other end of an HDMI cable to the HDMI OUT connector of the computer.
- 2 Press the **Source** button on the remote control and choose **HDMI** as an input source.

Note:

- ◆ When working with 3840x2160 30&60Hz timing, a HDMI 2.0 certified cable is required in order to display properly.

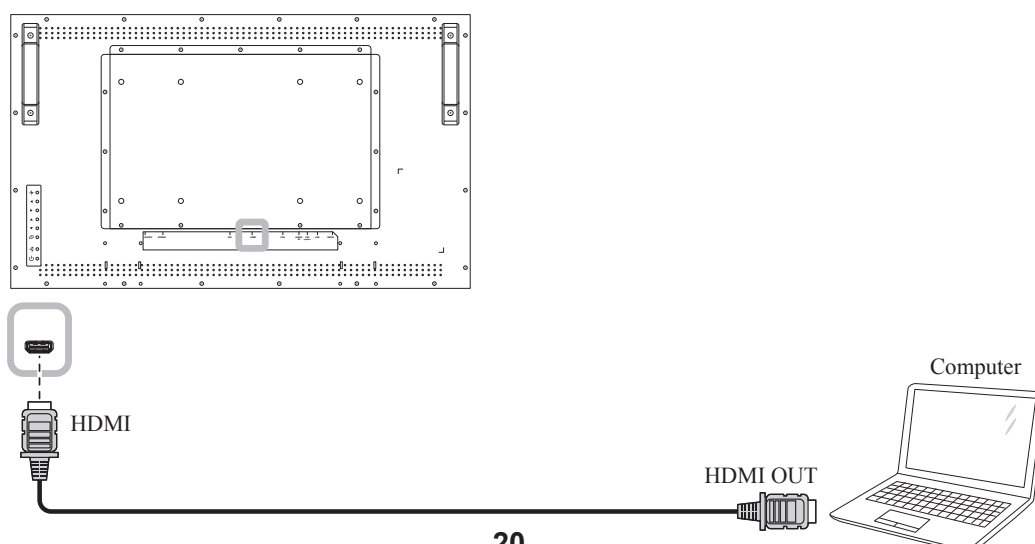

MAKING CONNECTIONS

2.2.3 Using DVI Input

- 1 Connect one end of a DVI cable to the DVI connector of the LCD display and the other end of a DVI cable to the DVI OUT connector of the computer.
- 2 For audio input, connect one end of an audio cable to the AUDIO IN connector of the LCD display and the other end of an audio cable to the AUDIO OUT connector of the computer.
- 3 Press the **Source** button on the remote control and choose **DVI** as an input source. Once selected, the audio input setting will automatically switch to the correct audio source for the video connection.

Note:

- ◆ When working with 3840x2160 30Hz, a DVI-Dual (DVI-D) cable is required.

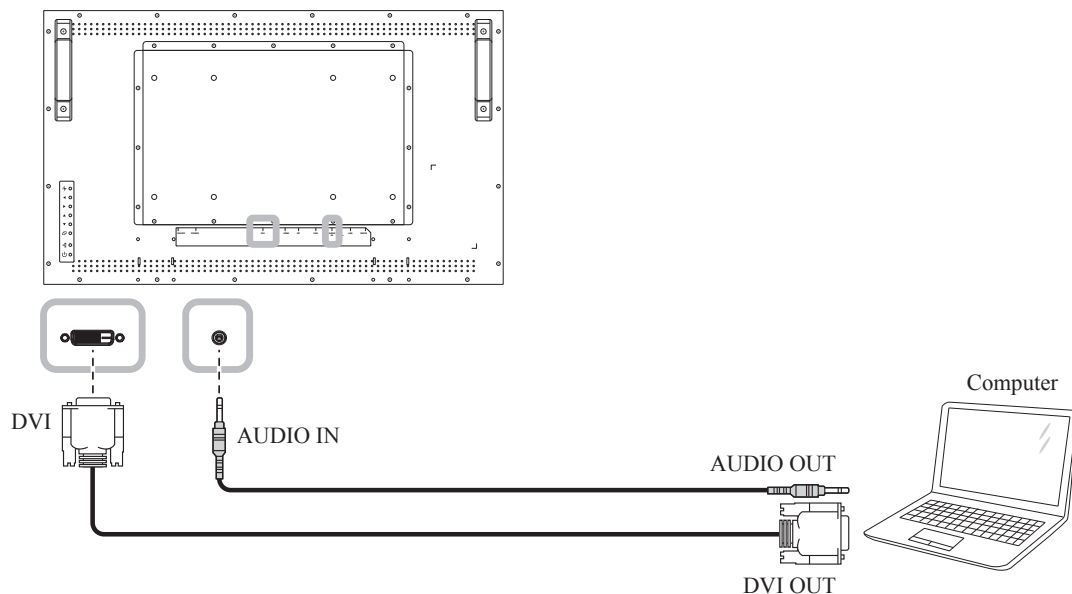

2.2.4 Using DisplayPort (DP) Input

- 1 Press the **Menu** button on the remote control to display the OSD menu and select **ADJUST SCREEN** to set the **DP VERSION**. Refer to “DP VERSION” on page 35 for more information.
- 2 Connect one end of a DisplayPort cable to the DisplayPort connector of the LCD display and the other end of a DisplayPort cable to the DisplayPort OUT connector of the computer.
- 3 Press the **Source** button on the remote control and choose **DP** as an input source.

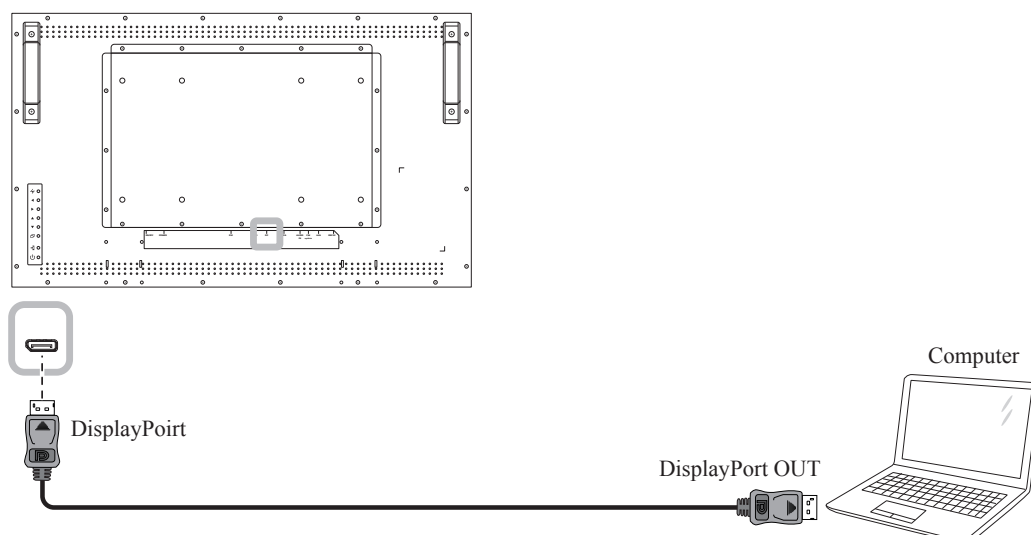

MAKING CONNECTIONS

2.3 Connecting External Equipment (DVD / DVD-B)

- 1 Connect one end of an HDMI cable to the HDMI connector of the LCD display and the other end of an HDMI cable to the HDMI OUT connector of the video player (DVD / DVD-B).
- 2 Press the **Source** button on the remote control and choose **HDMI** as an input source.
- 3 Press the **Menu** button to display the OSD menu and choose **SYSTEM 1 > AUDIO IN** to set the audio input source to **HDMI**.

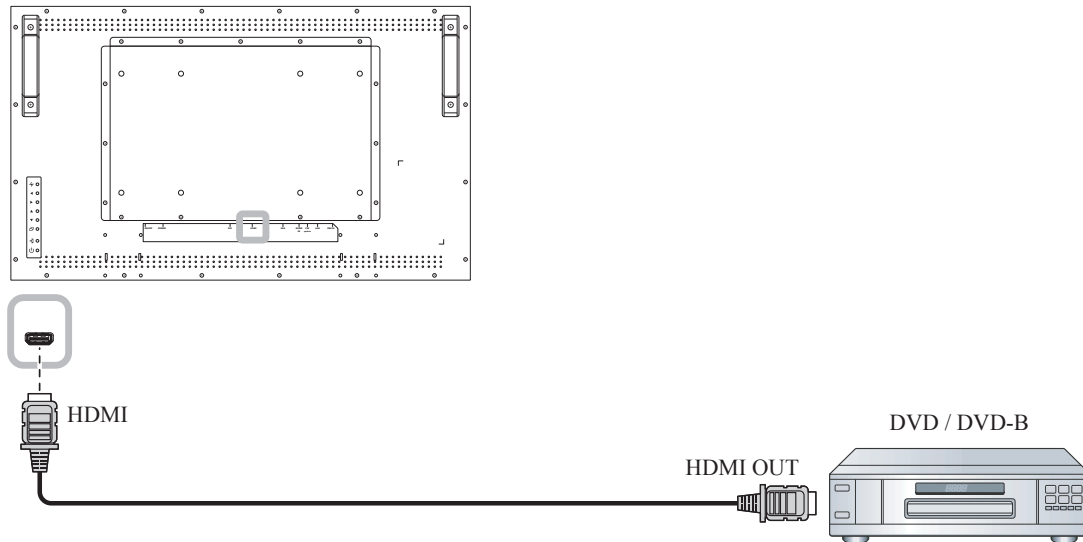

2.4 Connecting a USB Storage Device (for firmware upgrade)

Connect a USB storage device to the USB port of the LCD display.

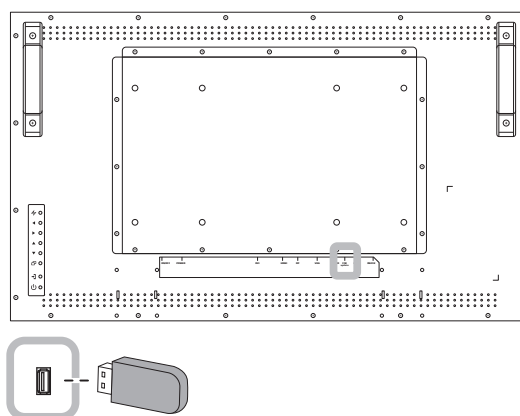

MAKING CONNECTIONS

2.5 Connecting to Wired Network

If you connect this LCD display to a home network, you can play photos, music, and videos from your computer.

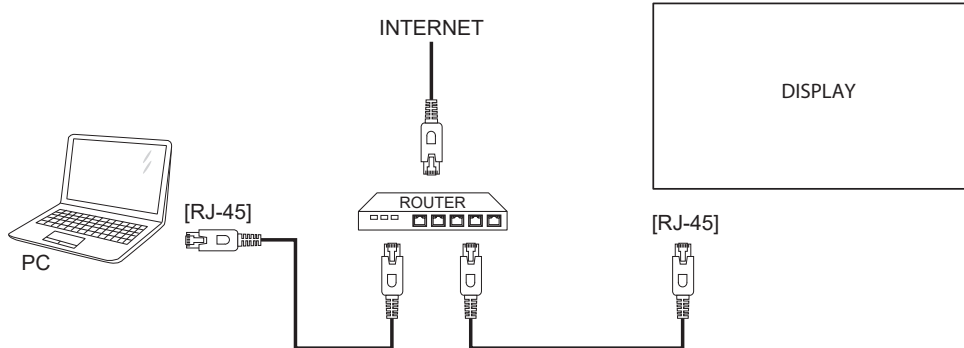

To setup the network:

- 1 Switch on the router and switch on its DHCP setting.
- 2 Connect the router to the LCD display with an Ethernet cable.
- 3 Press the **Menu** button to display the OSD menu and choose **SYSTEM 2 > NET MODE** to **DHCP**. Refer to 52.



Note:

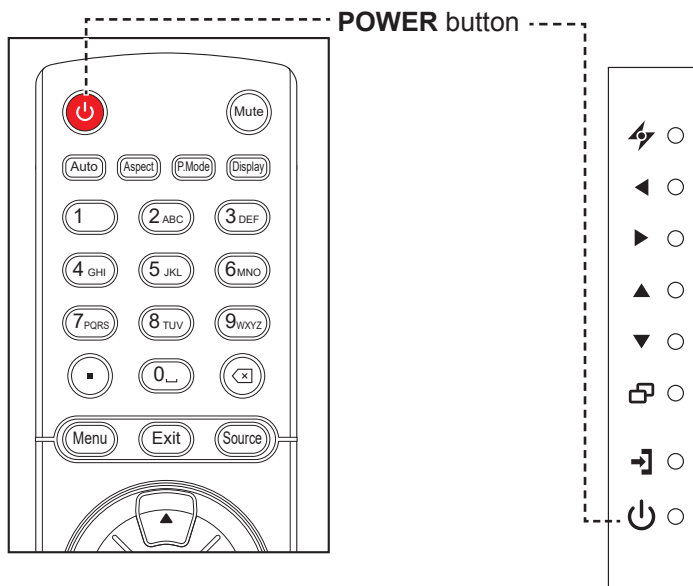

- ◆ Connecting with a shielded CAT-5 Ethernet cable to comply with the EMC directive.
- ◆ To manually configure the network parameters, set the **NET MODE** to **STATIC IP**.

CHAPTER 3: USING THE LCD DISPLAY

3.1 Turning on the Power



- 1 Plug the power cord to a power outlet or power supply.
- 2 Set the **Main Power** switch to ON.
- 3 Press the  button on the control panel or the  button on the remote control to turn the LCD display on.



When the LCD display is turned on, press the  button on the control panel or the  button on the remote control to turn off the LCD display.

Note:

- ◆ The LCD display still consumes power as long as the power cord is connected to the power outlet. Disconnect the power cord to completely cut off power.

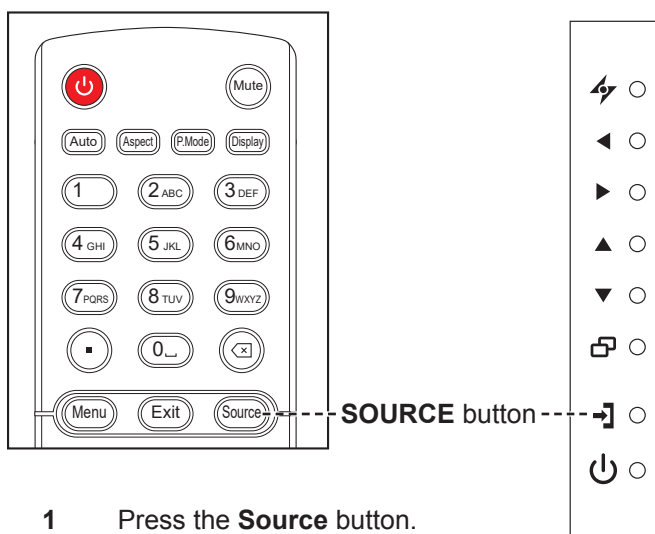
3.2 Selecting the Input Source Signal



- 1 Press the **Source** button.
- 2 Press the  /  button to choose an input source, then press the **SET** button.

Note:

- ◆ After pressing the **Source** button, a menu with available input sources will be displayed on the screen.



- ◆ If the selected input source signal is not connected to the LCD display or is turned off, the no signal message is displayed on the screen.



USING THE LCD DISPLAY

3.3 Adjusting the Volume

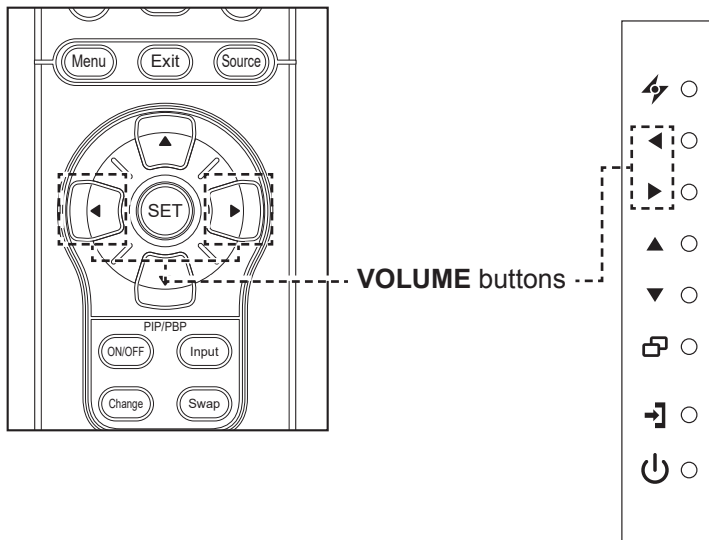

Press the ◀ or ▶ button on the control panel or the remote control to adjust the volume.

Note:

- ◆ After pressing the ◀ or ▶ button, the volume menu is displayed on the screen automatically.



- ◆ Press the **Mute** button to mute the audio.

3.4 Changing the Picture Format

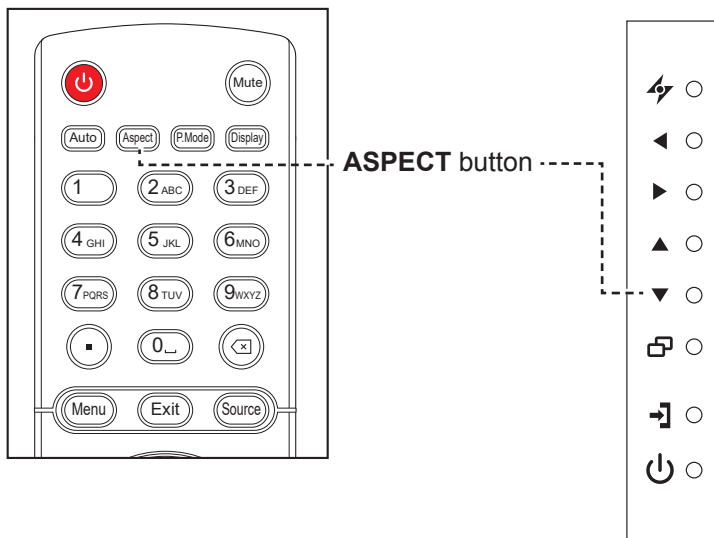

Press the ▼ button on the control panel or the **Aspect** button on the remote control to toggle between the picture formats.

Note:

The available picture formats include:

- ◆ **WIDE SCREEN:** Shows wide screen format content unstretched.
- ◆ **AUTO:** Enlarges the picture to fill the screen. Recommended for minimal screen distortion.
- ◆ **4:3:** Displays the classic 4:3 format.
- ◆ **5:4:** Displays picture in 5:4 format.
- ◆ **1:1:** Displays picture in square format.

USING THE LCD DISPLAY

3.5 Choosing Your Preferred Picture Settings

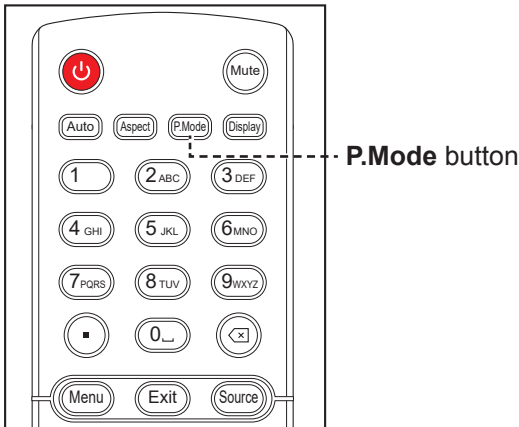

Press the **P.Mode** button to toggle between the picture modes.

3.6 Using Auto Adjustment Function

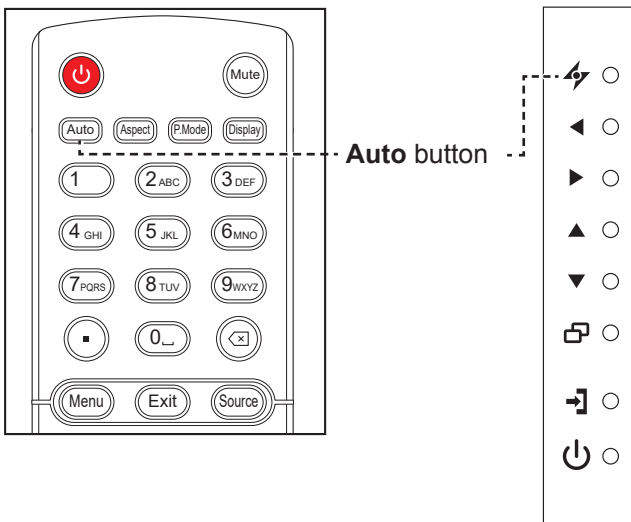

Auto Adjustment function automatically tunes the LCD display to its optimal setting, including horizontal position, vertical position, clock, and phase.

Touch the  button on the control panel or the **Auto** button on the remote control to perform auto adjustment.

The message auto adjusting is displayed on the screen.



During auto adjustment, the screen will slightly shake for a few seconds.

When the message disappears, auto adjustment is completed.

Note:

The available picture modes include:

- ◆ **STANDARD:** Default settings that suits most environments and types of video.
- ◆ **TEXT:** Automatically optimizes sharpness for reading text on the screen.
- ◆ **ECO:** Settings that conserve the most energy.
- ◆ **CCTV:** Settings adjusted for monitoring CCTV.
- ◆ **SIGNAGE-GRAPHICS:** Settings adjusted for graphics.
- ◆ **SIGNAGE-VIDEO:** Settings adjusted for video.

Note:

- ◆ Auto Adjustment function is available only during VGA input signals.
- ◆ It is recommended to use the auto adjustment function when using the LCD display for the first time or after a resolution change.

USING THE LCD DISPLAY

3.7 Using Multi-Window Mode

The Multi-Window feature allows viewing of more than one input source signal on the LCD display.

3.7.1 Multi-Window Options

For Control Panel:

Press the ▲ button repeatedly to enable and scroll among the Multi-Window options as shown below.

For Remote Control:

- 1 In PIP/PBP control section, press the **ON/OFF** button to enable the function.
- 2 Press the **Change** button repeatedly to scroll among the Multi-Window options as shown below.

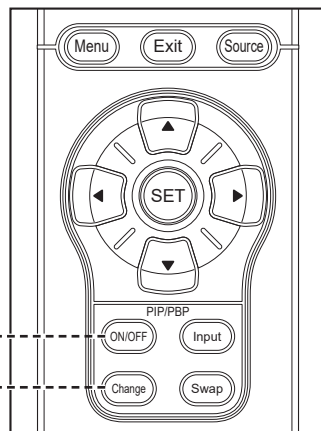

PIP Off



PIP MODE



PBP 2WIN



PBP 4WIN

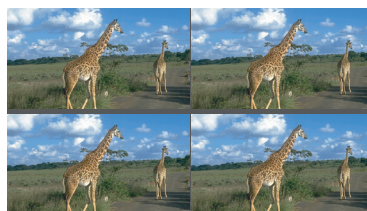

PBP 3WIN

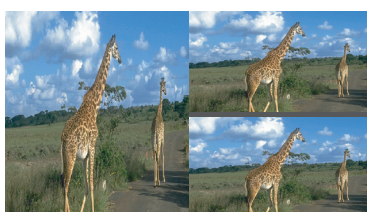

Info:

- ◆ **PIP** (Picture-in-Picture) **MODE**: The sub source signal is displayed within the main source signal.
- ◆ **PBP** (Picture-by-Picture): The main source and the sub source signals are displayed side by side with equal display sizes. The available options include:
 - **PBP 2WIN**: The main source and the sub sources next to each other.
 - **PBP 3WIN**: The main source and two sub sources.
 - **PBP 4WIN**: The main source and three sub sources.
- ◆ **PIP Off**: PIP function is disabled, only the main source signal is displayed.

USING THE LCD DISPLAY

3.7.2 PIP Swap

The main and the sub source signals set in PIP Mode can be easily swapped using the remote control.









Press the **Swap** button to swap the main source and the sub source signals as shown below.



3.7.3 Setting the Sub-Source Signals

Press the **Input** button on the remote control to set the input source signal for PIP Mode.

To set the input signal sources for PBP 2WIN, PBP 3WIN, and PBP 4WIN, use the OSD menu. After you have chosen the desired multi-window mode, do the following to set the input source signals for sub source(s):

- 1 Press the  button on the control panel or the **MENU** button on the remote control to call out the OSD window.
- 2 Select **MULTI WINDOW**, then press the  button on the control panel or the **SET** button on the remote control.
- 3 Press the  /  button on the control panel or the remote control to choose the input source for the sub source(s) among **WINDOW 2 INPUT**, **WINDOW 3 INPUT**, or **WINDOW 4 INPUT**.
- 4 Press the  /  button on the control panel or the remote control to set the input source for the sub source.
- 5 Press the  button on the control panel or the **SET** button on the remote control to confirm the selection.
- 6 Repeat steps 3 and 5 if necessary until input source signals are set for all sub sources.

Note:





- ◆ PIP Swap can only be executed if **MULTI-WINDOW MODE** is set to **PIP MODE**.

Note:

- ◆ The sub sources' window input options vary depending on the chosen multi-window mode.

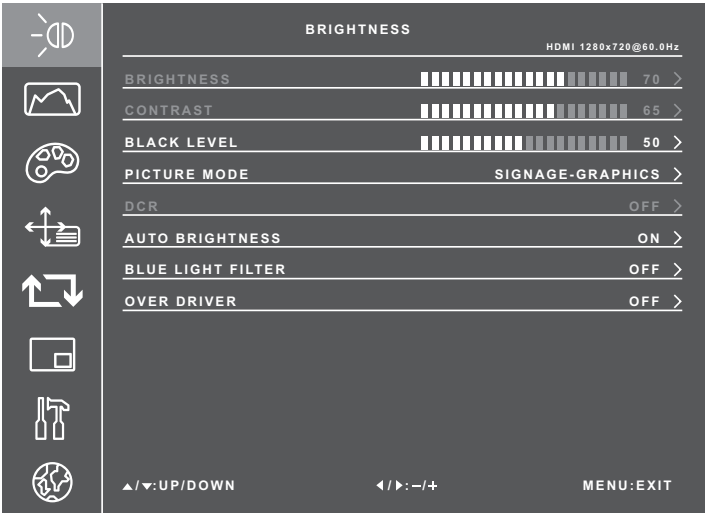
CHAPTER 4: ON SCREEN DISPLAY MENU

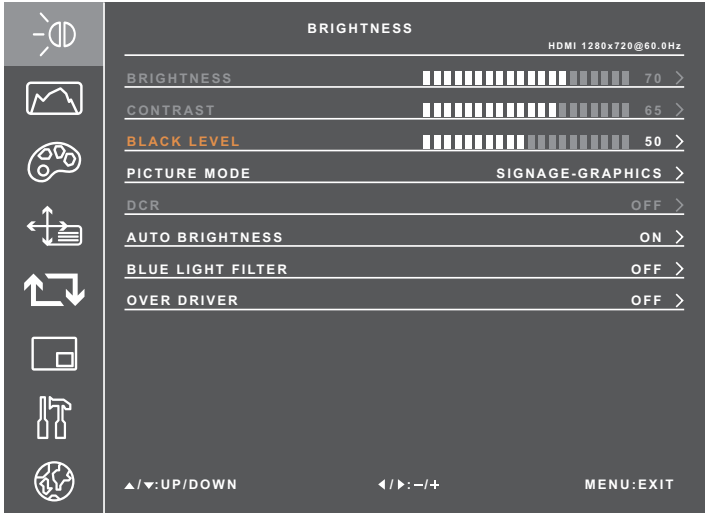
4.1 Using the OSD Menu

#	Menu Navigation	Operation	
		Control Panel	Remote Control
1	<p>Display the main menu screen.</p> 	Press the  button.	Press the MENU button.
2	<p>Enter the submenu.</p> 	<p>1 Press the ▲ or ▼ button to select the main menu item.</p> <p>2 Press the  button to enter the submenu.</p>	<p>1 Press the ▲ or ▼ button to select the main menu item.</p> <p>2 Press the SET button to enter the submenu.</p>

The highlighted item (orange) indicates the active submenu.

ON SCREEN DISPLAY MENU

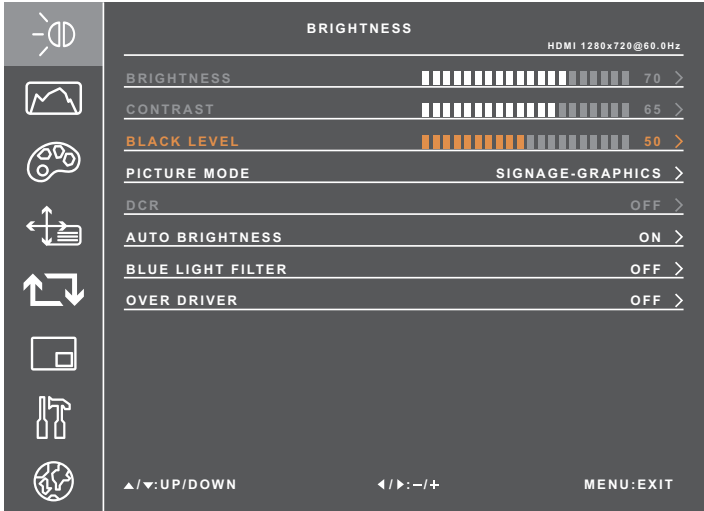
#	Menu Navigation	Operation	
		Control Panel	Remote Control
3	<p>Adjust the settings. The highlighted item indicates the active submenu. For example:</p> 	<ol style="list-style-type: none"> 1 Press the ▲ or ▼ button to select the submenu item. 2 Press the □ button to enter the adjustment mode. 3 Press the ◀ or ▶ button to adjust the setting. 	<ol style="list-style-type: none"> 1 Press the ▲ or ▼ button to select the submenu item. 2 Press the SET button to enter the adjustment mode. 3 Press the ◀ or ▶ button to adjust the settings.
4	Exit the submenu.	Press the ⚡ button to return to the previous menu.	Press the EXIT button to return to the previous menu.
5	Close the OSD window.	Press the ⚡ button repeatedly if necessary.	Press the EXIT button repeatedly if necessary.

When settings are modified, all changes are saved when the user does the following:

- Proceeds to another menu.
- Exits the OSD menu.
- Waits for the OSD menu to disappear.

Note:

- ◆ Availability of some menu items depend on the input source signal.

ON SCREEN DISPLAY MENU

4.2 OSD Menu Tree

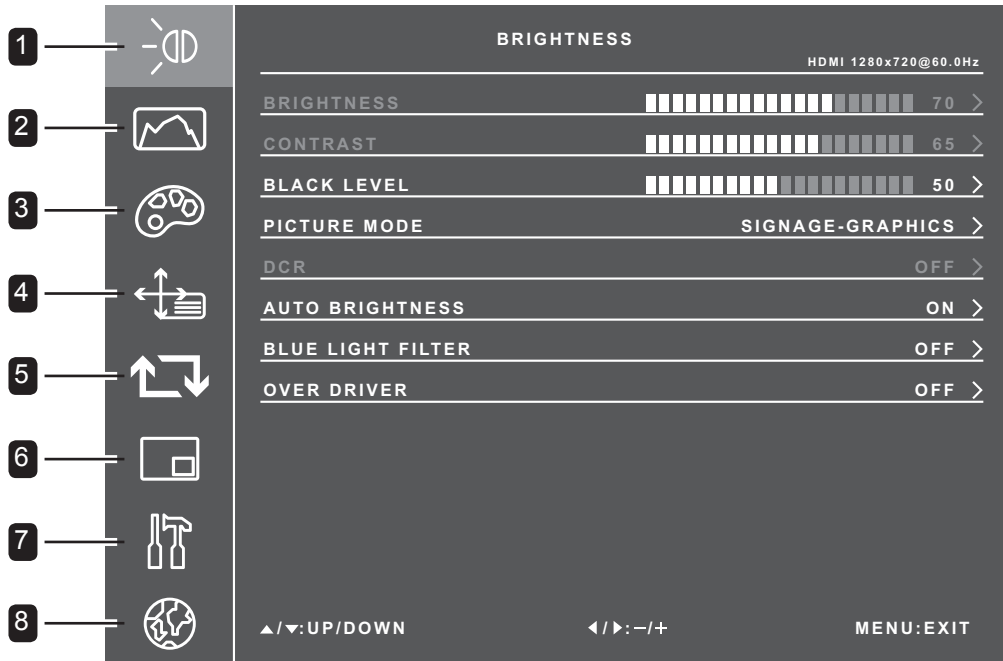

Main Menu	Submenu	Remarks
1. Brightness	<ul style="list-style-type: none"> • BRIGHTNESS • CONTRAST • BLACK LEVEL • PICTURE MODE • DCR • AUTO BRIGHTNESS • BLUE LIGHT FILTER • OVER DRIVER 	Refer to page 33.
2. Adjust Screen	<ul style="list-style-type: none"> • H. POSITION • V. POSITION • CLOCK • PHASE • ASPECT RATIO • OVERSCAN • DP VERSION 	Refer to page 35.
3. Colour Setting	<ul style="list-style-type: none"> • COLOUR TEMP. • GAMMA • SHARPNESS • HUE • SATURATION • SUPER RESOLUTION • NOISE REDUCTION • DYNAMIC LUMINOUS CONTRAST 	Refer to page 35.

ON SCREEN DISPLAY MENU

Main Menu	Submenu	Remarks
4. OSD Setting	<ul style="list-style-type: none"> • LANGUAGE • OSD H. POS. • OSD V. POS. • OSD TIMER • TRANSPARENCY • OSD SIZE • OSD ROTATION 	Refer to page 39.
5. All Reset	<ul style="list-style-type: none"> • AUTO ADJUSTING • AUTO COLOUR • USB FW UPGRADE • RESET 	Refer to page 40.
6. Multi Window	<ul style="list-style-type: none"> • MULTI-WINDOW MODE • WINDOW 2 INPUT • WINDOW 3 INPUT • WINDOW 4 INPUT • PIP SIZE • PIP POSITION • SWAP 	Refer to page 41.
7. System 1	<ul style="list-style-type: none"> • SIGNAL SOURCE • SOURCE DETECT • MUTE • AUDIO IN • VOLUME • KEY LOCK • IR LOCK • POWER AT COLD START • POWER SAVING • ANTI-BURN-IN • INFORMATION 	Refer to page 42.
8. System 2	<ul style="list-style-type: none"> • MONITOR ID • DATE • TIME • SCHEDULING • NETWORK SETTING 	Refer to page 45.

Note:

- ◆ Availability of some menu items depend on the input source signal.

CHAPTER 5: ADJUSTING THE LCD DISPLAY

5.1 Brightness Menu

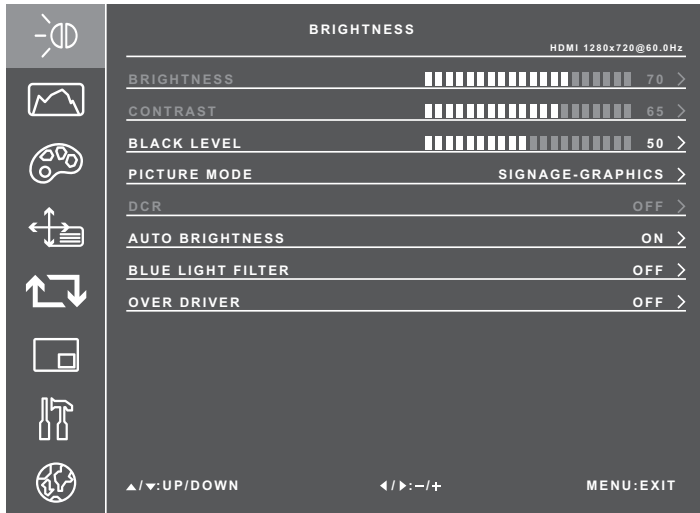

- 1 Press the button on the control panel or the **MENU** button on the remote control to call out the OSD window.
- 2 Select **BRIGHTNESS**, then press the button on the control panel or the **SET** button on the remote control.
- 3 Press the button on the control panel or the remote control to select an option.
- 4 Press the button on the control panel or the **SET** button on the remote control to enter the adjustment mode.

Item	Function	Operation	Range
BRIGHTNESS	Adjusts the luminance of the screen image.	Press the button on the control panel or the remote control to adjust the value.	0 to 100
	Note: ♦ BRIGHTNESS option is available only if PICTURE MODE is set to STANDARD , the AUTO BRIGHTNESS is set to OFF , and the DCR is set to OFF .		

<i>Original Setting High Setting Low Setting</i>			
CONTRAST	Adjusts the difference between the black level and the white level.	Press the button on the control panel or the remote control to adjust the value.	0 to 100
	Note: ♦ CONTRAST option is available only if PICTURE MODE is set to STANDARD and the DCR is set to OFF .		

<i>Original Setting High Setting Low Setting</i>			

ADJUSTING THE LCD DISPLAY

Item	Function	Operation	Range
BLACK LEVEL	Adjusts the black level of the screen image. Low brightness setting makes black colour darker.	Press the ◀/▶ button on the control panel or the remote control to adjust the value.	0 to 100
	Note: ♦ BLACK LEVEL option is available only if PICTURE MODE is set to STANDARD , TEXT , ECO , or SIGNAGE-GRAPHICS .		
PICTURE MODE	Chooses a predefined picture setting. PICTURE MODE can be set to: <ul style="list-style-type: none"> • CCTV – Loads colour, black level, sharpness, and contrast ratio settings to improve CCTV image quality from unfavourable surveillance environments. • SIGNAGE-GRAPHICS – Loads colour, sharpness, and contrast ratio settings for viewing clear and eye-catching graphics in distance, designed for signage applications. • SIGNAGE-VIDEO – Loads colour, sharpness, and contrast ratio settings for viewing clear and eye-catching video in distance, designed for signage applications. 	Press the ◀/▶ button on the control panel or the remote control to select the setting.	STANDARD TEXT ECO CCTV SIGNAGE-GRAPHICS SIGNAGE-VIDEO
DCR	Adjusts the clarity and focus of the screen image.	Press the ◀/▶ button on the control panel or the remote control to select the setting.	ON OFF
AUTO BRIGHTNESS (Light sensor)	Automatically adjusts the LCD screen brightness according to the ambient light.	Press the ◀/▶ button on the control panel or the remote control to select the setting.	ON OFF
BLUE LIGHT FILTER	Reduces the blue light intensity.	Press the ◀/▶ button on the control panel or the remote control to select the setting.	OFF WEAK MEDIUM STRONG STRONGEST
OVER DRIVER	Enhances the monitor response time.	Press the ◀/▶ button on the control panel or the remote control to select the setting.	OFF WEAK MEDIUM STRONG

ADJUSTING THE LCD DISPLAY

5.2 Adjust Screen Menu

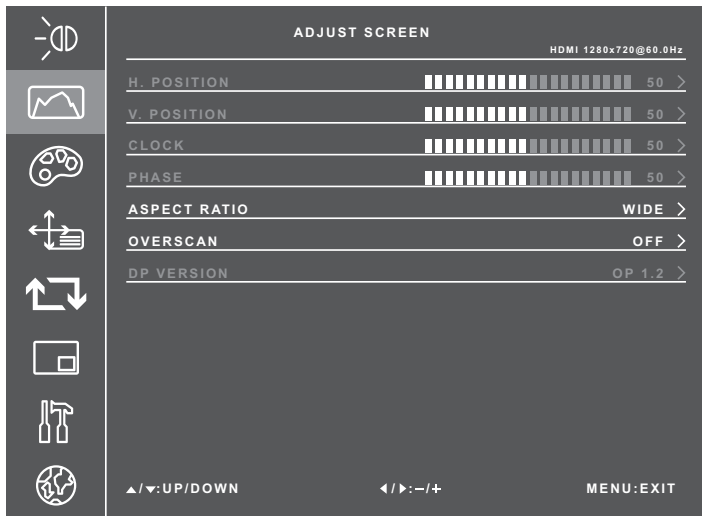





- 1 Press the button on the control panel or the **MENU** button on the remote control to call out the OSD window.
- 2 Select **ADJUST SCREEN**, then press the button on the control panel or the **SET** button on the remote control.
- 3 Press the **▲/ ▼** button on the control panel or the remote control to select an option.
- 4 Press the button on the control panel or the **SET** button on the remote control to enter the adjustment mode.

Item	Function	Operation	Range
H. POSITION	For VGA input signal source, moves the screen image to the left or right.	Press the ◀/ ▶ button on the control panel or the remote control to adjust the value.	0 to 100
V. POSITION	For VGA input signal source, moves the screen image up or down.	Press the ◀/ ▶ button on the control panel or the remote control to adjust the value.	0 to 100
CLOCK	For VGA input signal source, adjusts the frequency timing to synchronize with the video signal.	Press the ◀/ ▶ button on the control panel or the remote control to adjust the value.	0 to 100
PHASE	For VGA input signal source, adjusts the phase timing to synchronize with the video signal.	Press the ◀/ ▶ button on the control panel or the remote control to adjust the value.	0 to 100
ASPECT RATIO	Adjusts the aspect ratio of the display.	Press the ◀/ ▶ button on the control panel or the remote control to select the setting.	WIDE AUTO 4:3 5:4 1:1
OVERSCAN	Displays the picture in full screen while retaining the original aspect ratio. This results in a zoomed image and some parts of the picture may appear cut-off.	Press the ◀/ ▶ button on the control panel or the remote control to select the setting.	ON OFF
DP VERSION	For DisplayPort (DP) input signal source, sets the DP port configuration. Note: ◆ DP 1.1 supports 3840x2160 30Hz. ◆ DP 1.2 supports 3840x2160 60Hz.	Press the ◀/ ▶ button on the control panel or the remote control to select the setting.	DP 1.1 DP 1.2

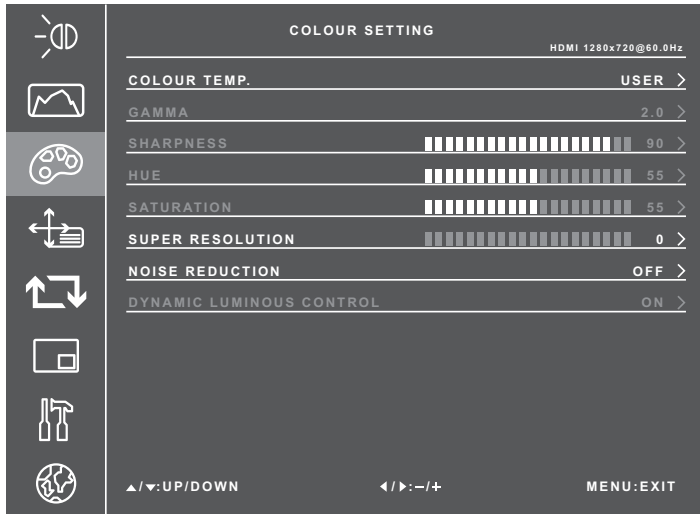



ADJUSTING THE LCD DISPLAY

5.3 Colour Setting Menu





- 1 Press the  button on the control panel or the **MENU** button on the remote control to call out the OSD window.
- 2 Select **COLOUR SETTING**, then press the  button on the control panel or the **SET** button on the remote control.
- 3 Press the  button on the control panel or the remote control to select an option.
- 4 Press the  button on the control panel or the **SET** button on the remote control to enter the adjustment mode.

ADJUSTING THE LCD DISPLAY

Item	Function	Operation	Range
COLOUR TEMP.	<p>Operates the white balance and automatically adjusts the colour settings.</p> <p>COLOUR TEMP. can be set to:</p> <ul style="list-style-type: none"> • WARM – Applies a reddish tint for warmer colours. • COOL – Applies a bluish tint for cooler colours. • NEUTRAL – Commonly used for normal lighting conditions. • USER – Allows the user to set the colour temperature by adjusting the red, green, or blue setting according to one's preference. <p>a) Select USER and press the  button on the control panel or the SET button on the remote control.</p> <p>b) Press the  button on the control panel or the remote control to select the colour you want to adjust (RED, GREEN, or BLUE).</p> <p>c) Press the  button on the control panel or the SET button on the remote control to enter its submenu.</p> <p>d) Press the  button on the control panel or the remote control to adjust the value.</p>	<p>Press the  button on the control panel or the remote control to select the setting.</p>	<p>WARM COOL NEUTRAL USER</p>

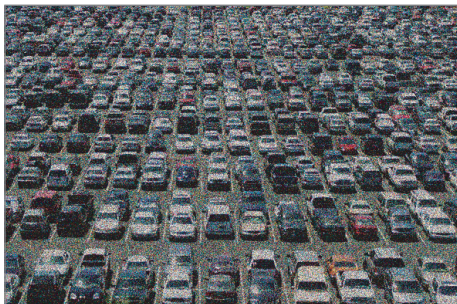

ADJUSTING THE LCD DISPLAY

Item	Function	Operation	Range
GAMMA	Adjusts the non-linear setting for picture luminance and contrast.	Press the ◀/▶ button on the control panel or the remote control to select the setting.	1.8 2.0 2.2 2.4 2.6
SHARPNESS	Adjusts the clarity and focus of the screen image.	Press the ◀/▶ button on the control panel or the remote control to adjust the value.	0 to 100
HUE	Adjusts the colour balance of red and green.	Press the ◀/▶ button on the control panel or the remote control to adjust the value.	0 to 100
SATURATION	Adjusts the colour saturation.	Press the ◀/▶ button on the control panel or the remote control to adjust the value.	0 to 100
SUPER RESOLUTION	Improves picture clearness.	Press the ◀/▶ button on the control panel or the remote control to adjust the value.	0 to 100
NOISE REDUCTION	Adjusts the noise reduction to help remove noise from images. This helps produce clearer and crisper images.	Press the ◀/▶ button on the control panel or the remote control to select the setting.	OFF LOW MEDIUM HIGH
	<div style="display: flex; justify-content: space-around;"> <div style="text-align: center;"> <p>Noise Reduction Off</p>  </div> <div style="text-align: center;"> <p>Noise Reduction On</p>  </div> </div>		
DYNAMIC LUMINOUS CONTRAST	Activates DCR. This feature provides automatic adjustment of picture brightness and contrast at high speed and dynamic contrast range, such as when watching movies. DCR is suitable for indoor viewing.	Press the ◀/▶ button on the control panel or the remote control to select the setting.	OFF ON

ADJUSTING THE LCD DISPLAY

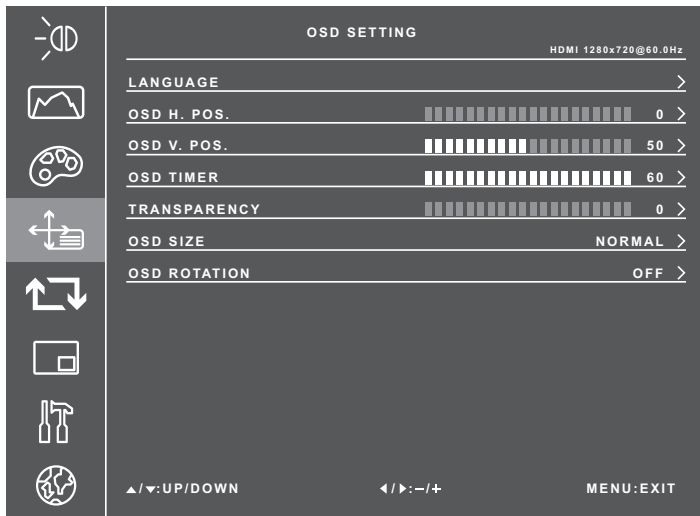
5.4 OSD Setting Menu







- 1 Press the  button on the control panel or the **MENU** button on the remote control to call out the OSD window.
- 2 Select **OSD SETTING**, then press the  button on the control panel or the **SET** button on the remote control.
- 3 Press the **▲/ ▼** button on the control panel or the remote control to select an option.
- 4 Press the  button on the control panel or the **SET** button on the remote control to enter the adjustment mode.

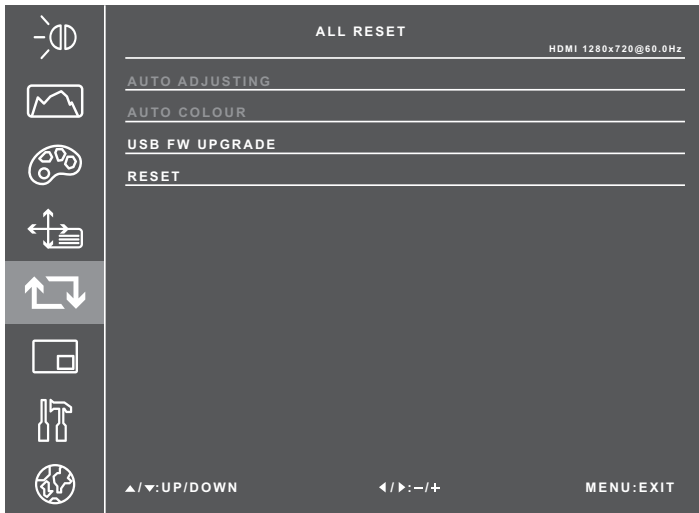

Item	Function	Operation	Range
LANGUAGE	Chooses the OSD menu language.	Press the ◀/ ▶ button on the control panel or the remote control to select the setting.	ENGLISH FRANÇAIS DEUTSCH 簡體中文 ESPAÑOL 繁體中文
OSD H. POS.	Moves the position of the OSD menu horizontally.	Press the ◀/ ▶ button on the control panel or the remote control to adjust the value.	0 to 100
OSD V. POS.	Moves the position of the OSD menu vertically.	Press the ◀/ ▶ button on the control panel or the remote control to adjust the value.	0 to 100
OSD TIMER	Changes the OSD menu timer settings where the number selected for this setting equals the number of seconds the OSD menu is displayed before it automatically closes (if 0 is selected the OSD menu will not close automatically).	Press the ◀/ ▶ button on the control panel or the remote control to adjust the value.	0 to 60
TRANSPARENCY	Adjusts the transparency level of the OSD screen.	Press the ◀/ ▶ button on the control panel or the remote control to adjust the value.	0 to 100
OSD SIZE	Changes the size of the OSD menu on the screen.	Press the ◀/ ▶ button on the control panel or the remote control to select the setting.	NORMAL SMALL
OSD ROTATION	Enables or disables the OSD menu rotation.	Press the ◀/ ▶ button on the control panel or the remote control to select the setting.	OFF ON

ADJUSTING THE LCD DISPLAY

5.5 All Reset Menu



- 1 Press the  button on the control panel or the **MENU** button on the remote control to call out the OSD window.
- 2 Select **ALL RESET**, then press the  button on the control panel or the **SET** button on the remote control.
- 3 Press the  /  button on the control panel or the remote control to select an option.





Item	Function	Operation	Range
AUTO ADJUSTING	<p>For VGA input signal source, this function automatically tunes the LED-backlit display to its optimal setting, including horizontal position, vertical position, clock, and phase.</p> <p>When auto adjustment is initiated, the below message is displayed on the screen.</p> <div style="text-align: center; border: 1px solid black; padding: 5px; width: fit-content; margin: 10px auto;"> <p>AUTO ADJUSTING</p> </div> <p>When the message disappears, this indicates the auto adjustment is completed.</p>	Press the  button on the control panel or the SET button on the remote control to execute the function.	N/A
AUTO COLOUR	For VGA input signal source, operates the white balance and automatically adjusts the colour settings.	Press the  button on the control panel or the SET button on the remote control to execute the function.	N/A
USB FW UPGRADE	<p>Upgrades display's firmware from a connected USB storage device.</p> <p>Note:</p> <ul style="list-style-type: none"> ◆ If the firmware upgrade status next to the USB FW UPGRADE line displays: <ul style="list-style-type: none"> – “USB NOT CONNECTED”: Make sure the USB disk with the firmware upgrade file is connected to the USB port on the LCD display. For connection instructions, refer to page 22. – “NO FILE FOUND”: Make sure the firmware upgrade file is saved to the root directory on the USB device. 	Press the  button on the control panel or the SET button on the remote control to execute the function.	N/A

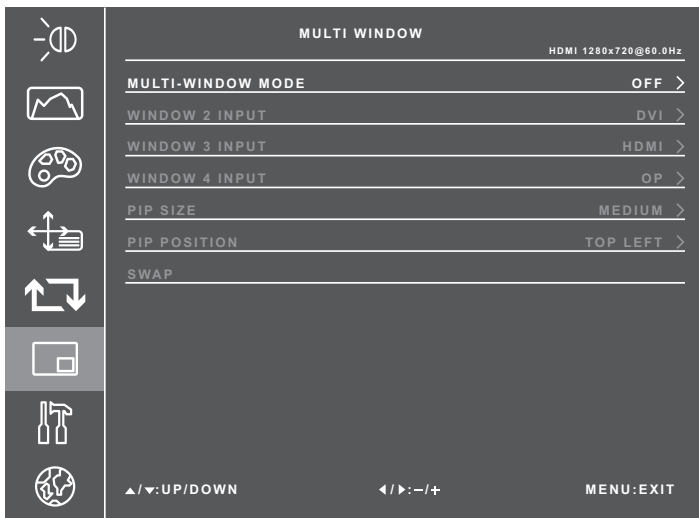

ADJUSTING THE LCD DISPLAY

Item	Function	Operation	Range
RESET	Resets the display to its factory default settings	Press the  button on the control panel or the SET button on the remote control to execute the function.	N/A

5.6 Multi Window Menu



- 1 Press the  button on the control panel or the **MENU** button on the remote control to call out the OSD window.
- 2 Select **MULTI WINDOW**, then press the  button on the control panel or the **SET** button on the remote control.
- 3 Press the  button on the control panel or the remote control to select an option.
- 4 Press the  button on the control panel or the **SET** button on the remote control to enter the adjustment mode.

Item	Function	Operation	Range
MULTI - WINDOW MODE	Chooses the multi-window mode.	<p>a) Press the  button on the control panel or the remote control to select PIP MODE, PBP 2WIN, PBP 3WIN, or PBP 4WIN as a sub source.</p> <p>b) Press the  button on the control panel or the SET button on the remote control to confirm the selection.</p>	<p>OFF</p> <p>PIP MODE</p> <p>PBP 2WIN</p> <p>PBP 3WIN</p> <p>PBP 4WIN</p>
	<p>Note:</p> <ul style="list-style-type: none"> ◆ The information on currently selected multi-window mode is displayed for reference below the menu options.  <ul style="list-style-type: none"> ◆ The main source input signal can be modified in System 1 > SIGNAL SOURCE menu. ◆ For setting input source signals for sub sources, refer to page 28. 		

ADJUSTING THE LCD DISPLAY

Item	Function	Operation	Range
PIP SIZE	Sets the size of the sub picture in the PIP (Picture-in-Picture) mode.	Press the ◀/▶ button on the control panel or the remote control to select the setting.	MEDIUM LARGE HUGE SMALL
PIP POSITION	Adjusts the placement of the sub picture in the PIP (Picture-in-Picture) mode.	Press the ◀/▶ button on the control panel or the remote control to select the setting.	TOP LEFT TOP RIGHT BOTTOM LEFT BOTTOM RIGHT
SWAP	Swaps the main source and sub source signals.	Press the □ button on the control panel or the SET button on the remote control.	N/A



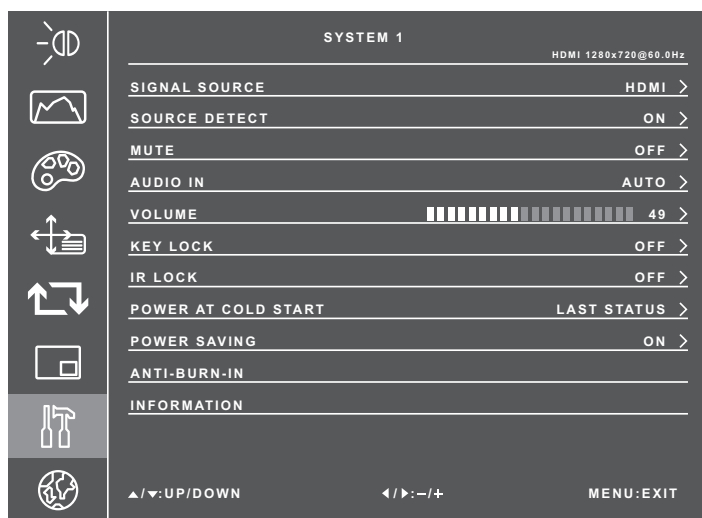



5.7 System 1 Menu

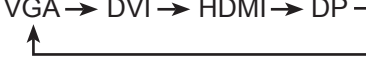

- 1 Press the □ button on the control panel or the **MENU** button on the remote control to call out the OSD window.
- 2 Select **SYSTEM 1**, then press the □ button on the control panel or the **SET** button on the remote control.
- 3 Press the ▲/▼ button on the control panel or the remote control to select an option.
- 4 Press the □ button on the control panel or the **SET** button on the remote control to enter the adjustment mode.

Item	Function	Operation	Range
SIGNAL SOURCE	Chooses the signal source.	Press the ◀/▶ button on the control panel or the remote control to select the setting.	VGA DVI HDMI DP





ADJUSTING THE LCD DISPLAY

Item	Function	Operation	Range
SOURCE DETECT	<p>Sets the display to automatically detect the input source signal.</p> <p>SOURCE DETECT can be set to:</p> <ul style="list-style-type: none"> • OFF – Allows user to manually select the input source signal by pressing the  button on the control panel or the Source button on the remote control. • ON – Detects automatically the input source signal. The speed to detection varies depending on the number and type of connected devices. <p>If more than one device is connected, the display scrolls the input source signals according to the following sequence:</p> <p>VGA → DVI → HDMI → DP</p> 	<p>Press the  button on the control panel or the remote control to select the setting.</p>	<p>OFF</p> <p>ON</p>
MUTE	Mutes the audio.	<p>Press the  button on the control panel or the remote control to select the setting.</p>	<p>OFF</p> <p>ON</p>
AUDIO IN	<p>Sets the audio in source.</p> <p>Availability of some menu items depend on the input source signal.</p>	<p>Press the  button on the control panel or the remote control to select the setting.</p>	<p>AUTO</p> <p>LINE IN</p> <p>HDMI</p>
VOLUME	Adjusts the volume level.	<p>Press the  button on the control panel or the remote control to adjust the value.</p>	0 to 100
KEY LOCK	<p>Enables or disables modifications to the OSD menu when using the control panel.</p> <p>KEY LOCK can be set to:</p> <ul style="list-style-type: none"> • OFF – Enables operations. • LOCK EXCEPT POWER – Disables all operations other than turning the display on or off (⏻). • LOCK ALL – Disables all operations. 	<p>a) Press the  button to select the setting.</p> <p>b) Press the  button to confirm the setting.</p>	<p>OFF</p> <p>LOCK EXCEPT POWER</p> <p>LOCK ALL</p>
	<p>Note:</p> <p>◆ For unlocking, refer to page 27.</p>		

ADJUSTING THE LCD DISPLAY





Item	Function	Operation	Range
IR LOCK	<p>Enables or disables modifications to the OSD menu when using the remote control.</p> <p>IR LOCK can be set to:</p> <ul style="list-style-type: none"> • OFF – Operations are enabled. • ON – All operations are disabled. 	<p>a) Press the ◀/▶ button to select the setting.</p> <p>b) Press the SET button to confirm the setting.</p>	<p>OFF</p> <p>ON</p>
	<p>Note:</p> <p>◆ To set the IR LOCK function to OFF, press buttons 1 9 9 8 on the remote control.</p>		
POWER AT COLD START	<p>Sets the power state at cold start.</p> <p>POWER AT COLD START can be set to:</p> <ul style="list-style-type: none"> • LAST STATUS – Switches the display automatically to the last status either on or off whenever the main power is switched on or resumed after the power interruption. • FORCE ON – Switches the display automatically to on mode whenever the main power is on or resumed after the power interruption. • POWER OFF – Switches the display automatically to off mode whenever the main power is on or resumed after the power interruption. 	<p>Press the ◀/▶ button on the control panel or the remote control to select the setting.</p>	<p>LAST STATUS</p> <p>FORCE ON</p> <p>POWER OFF</p>

ADJUSTING THE LCD DISPLAY

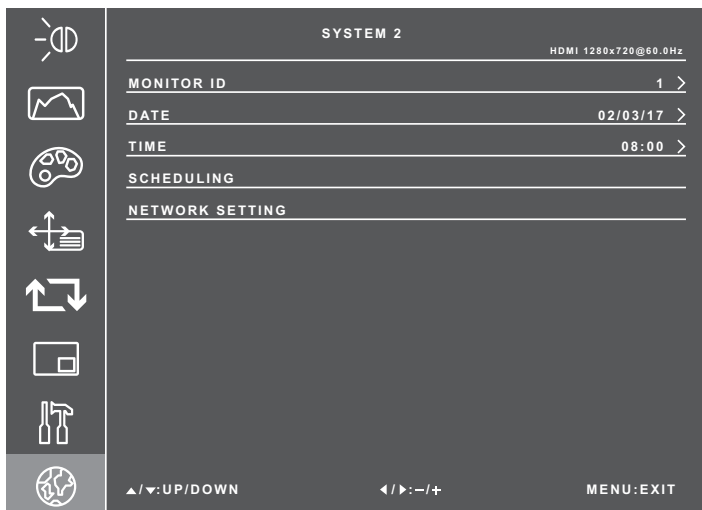

Item	Function	Operation	Range
ANTI-BURN-IN	Prevents image retention (burn-in).	<p>a) Press the  button on the control panel or the SET button on the remote control to open the ANTI-BURN-IN submenu.</p> <p>b) Press the  /  button on the control panel or the remote control to select the submenu items.</p> <p>c) Press the  button on the control panel or the SET button on the remote control to enter the adjustment mode.</p> <p>d) Do the following:</p> <p>i) Set the ANTI-BURN-IN function to ON.</p> <p>ii) Choose the INTERVAL (4, 5, 6, 8 HOURS).</p>	ON OFF
INFORMATION	Provides information on the LCD display, such as current input source, resolution, horizontal and vertical frequency, firmware version, and many more.	Press the  button on the control panel or the SET button on the remote control.	N/A

5.8 System 2 Menu



- 1 Press the  button on the control panel or the **MENU** button on the remote control to call out the OSD window.
- 2 Select **SYSTEM 2**, then press the  button on the control panel or the **SET** button on the remote control.
- 3 Press the  /  button on the control panel or the remote control to select an option.
- 4 Press the  button on the control panel or the **SET** button on the remote control to enter the adjustment mode.

ADJUSTING THE LCD DISPLAY





Item	Function	Operation	Range
MONITOR ID	Sets the ID of the display.	Press the ◀/▶ button on the control panel or the remote control to adjust the value.	1 to 255
DATE	Sets the date in MM/DD/YY format.	<p>a) Press the ◀/▶ button on the control panel or the remote control to set the month.</p> <p>b) After done, press the ▲/▼ button on the control panel or the remote control to move to day parameter.</p> <p>c) Repeat steps a and b until the date is set.</p>	N/A
TIME	Sets the time in HH:MM format.	<p>a) Press the ◀/▶ button to set the hours.</p> <p>b) After done, press the ▲/▼ button to move to minutes parameter.</p> <p>c) Press the ◀/▶ button on the control panel or the remote control to set the minutes.</p>	N/A
SCHEDULING	<p>Programs different scheduled time intervals for this display to activate.</p> <p>You can set:</p> <ul style="list-style-type: none"> • SCHEDULE 1 / 2 / 3 – Programs up to three different schedules. • STATUS – Sets the schedule to ON or OFF. • SOURCE – Chooses which input source the display will use for each scheduled activation period among VGA, DVI, HDMI, and DP. • ON TIME – Sets the time when the display will automatically turn on. • OFF TIME – Sets the time when the display will automatically turn off. • REPEAT – Chooses the days in a week when the schedule is activated. 	<p>a) Press the  button on the control panel or the SET button on the remote control to open the SCHEDULING submenu.</p> <p>b) Press the ▲/▼ button on the control panel or the remote control to select the submenu items.</p> <p>c) Press the  button on the control panel or the SET button on the remote control to enter the adjustment mode.</p> <p>d) Press the ◀/▶ button to select the setting or adjust the value.</p>	N/A
<p>Note:</p> <ul style="list-style-type: none"> ◆ We recommend you to set up the current date and time prior using this function. 			

ADJUSTING THE LCD DISPLAY

Item	Function	Operation	Range
NETWORK SETTING	<p>Configures network settings.</p> <ul style="list-style-type: none"> • NET MODE – Sets the network mode to DHCP or STATIC IP depending on the network type. <p>DHCP: Obtains connection parameters automatically from the network.</p> <p>STATIC IP: Network parameters, such as IP ADDRESS, SUBNET MASK, GATEWAY, PRIMARY DNS, and SECONDARY DNS need to be entered manually.</p> <p>To modify IP address, subnet mask, gateway, primary DNS, and secondary DNS:</p> <ol style="list-style-type: none"> Press the ▲ / ▼ button on the control panel or the remote control to select the submenu item. Press the □ button on the control panel or the SET button on the remote control to enter the adjustment mode. Press the necessary number button on the remote control directly or press the ▲ / ▼ button on the control panel or the remote control to enter the number. Press the ◀ / ▶ button on the control panel or the remote control to move to the next number that needs to be set. <ul style="list-style-type: none"> • WAKE ON LAN – Enables or disables turning on the display over network. • MONITOR NAME – Sets a monitor name. 	<ol style="list-style-type: none"> Press the □ button on the control panel or the SET button on the remote control to open the NETWORK SETTING submenu. Press the ▲ / ▼ button on the control panel or the remote control to select the submenu items. Press the □ button on the control panel or the SET button on the remote control to enter the adjustment mode. Press the ◀ / ▶ button on the control panel or the remote control to select the setting or adjust the value. 	N/A

CHAPTER 6: APPENDIX

6.1 Warning Messages

Warning Messages	Cause	Solution
	<p>The LCD display cannot detect the input source signal.</p>	<ul style="list-style-type: none"> • Check if the input source is turned ON. • Check if the signal cable is properly connected. • Check if any pin inside the cable connector is twisted or broken.
	<p>The operation using the control panel buttons has been locked by the user.</p>	<ul style="list-style-type: none"> • Disable the KEY LOCK function.
	<p>The operation using the remote control buttons has been locked by the user.</p>	<ul style="list-style-type: none"> • Disable the IR LOCK function. Refer to page 44.
	<p>The resolution or the refresh rate of the graphics card of the computer is set too high.</p>	<ul style="list-style-type: none"> • Change the resolution or the refresh rate of the graphics card.

APPENDIX

6.2 Supported Resolution

Supported Resolution:

Standard Resolution	Active Resolution		Refresh Rate
	H Pixels	V Lines	
VGA	640	480	60 Hz
WVGA	720	400	70 Hz
SVGA	800	600	56 Hz
			60 Hz
XGA	1024	768	60 Hz
WXGA	1280	800	60 Hz
SXGA	1280	960	60 Hz
SXGA	1280	1024	60 Hz
WXGA	1440	900	60 Hz
WSXGA	1680	1050	60 Hz
HD 1080	1920	1080	60 Hz
UHD (HDMI/DP)	3840	2160	30 Hz
	3840	2160	60 Hz

SDTV Resolution:

Standard Resolution	Active Resolution		Refresh Rate
	H Pixels	V Lines	
480p	640	480	60 Hz
480p	720	480	60 Hz
480i			
576p	720	576	50 Hz
576i			

HDTV Resolution:

Standard Resolution	Active Resolution		Refresh Rate
	H Pixels	V Lines	
720p	1280	720	50 Hz
			60 Hz
1080p	1920	1080	50 Hz
			60 Hz
1080i	1920	1080	50 Hz
			60 Hz

APPENDIX

General guidelines:

- The PC text quality is optimum in 4K mode (3840x2160 60Hz).
- Your PC display screen might appear different depending on the manufacturer (and your particular version of Windows).
- Check your PC instruction book for information about connecting your PC to a display.
- When horizontal synchronous signals seem irregular in RGB mode, check PC power saving mode or cable connections.
- The display settings table complies to the IBM/VESA standards, and based on the analog input.
- The DVI support mode is regarded as same to the PC support mode.
- The best timing for the vertical frequency to each mode is 60Hz.

6.3 Cleaning

Caution When Using the Display

- Do not bring your hands, face or objects close to the ventilation holes of the display. The top of the display is usually very hot due to the high temperature of exhaust air being released through the ventilation holes. Burns or personal injuries may occur if any body parts are brought too close. Placing any object near the top of the display could also result in heat related damage to the object as well as the display itself.
- Be sure to disconnect all cables before moving the display. Moving the display with its cables attached may damage the cables and thus cause fire or electric shock.
- Disconnect the power plug from the wall outlet as a safety precaution before carrying out any type of cleaning or maintenance procedure.

Front Panel Cleaning Instructions

- The front of the display has been specially treated. Wipe the surface gently using only a cleaning cloth or a soft, lint-free cloth.
- If the surface becomes dirty, soak a soft, lint-free cloth in a mild detergent solution. Wring the cloth to remove excess liquid. Wipe the surface of the display to remove dirt. Then use a dry cloth of the same type to dry.
- Do not scratch or hit the surface of the panel with fingers or hard objects of any kind.
- Do not use volatile substances such as insert sprays, solvents and thinners.

Cabinet Cleaning Instructions

- If the cabinet becomes dirty, wipe the cabinet with a soft, dry cloth.
- If the cabinet is extremely dirty, soak a lint-free cloth in a mild detergent solution. Wring the cloth to remove as much moisture as possible. Wipe the cabinet. Use another dry cloth to wipe over until the surface is dry.
- Do not allow any water or detergent to come into contact with the surface of the display. If water or moisture gets inside the unit, operating problems, electrical and shock hazards may result.
- Do not scratch or hit the cabinet with fingers or hard objects of any kind.
- Do not use volatile substances such as insert sprays, solvents and thinners on the cabinet.
- Do not place anything made from rubber or PVC near the cabinet for any extended periods of time.

APPENDIX

6.4 Troubleshooting

Symptom	Possible Cause	Remedy
No picture is displayed	<ul style="list-style-type: none"> The main power switch on the back of the display is not switched on. The selected input has no connection. The display is in standby mode. 	<ol style="list-style-type: none"> 1 Plug in the power cord. 2 Make sure the power switch is switched on. 3 Connect a signal connection to the display.
Interference displayed on the display or audible noise is heard	Caused by surrounding electrical appliances or fluorescent lights.	Move the display to another location to see if the interference is reduced.
Colour is abnormal	The signal cable is not connected properly.	Make sure that the signal cable is attached firmly to the back of the display.
Picture is distorted with abnormal patterns	<ul style="list-style-type: none"> The signal cable is not connected properly. The input signal is beyond the capabilities of the display. 	<ul style="list-style-type: none"> Make sure that the signal cable is attached firmly. Check the video signal source to see if it is beyond the range of the display. Please verify its specifications with this display's specification section.
Display image doesn't fill up the full size of the screen	The picture format is not set correctly.	Press the ▼ button on the control panel or the Aspect button on the remote control and select the suitable picture format.
Can hear sound, but no picture	Improperly connected source signal cable.	Make sure that both video inputs and sound inputs are correctly connected.
Can see picture but no sound is heard	<ul style="list-style-type: none"> Improperly connected source signal cable. Volume is turned all the way down. MUTE function is turned on. No external speaker connected. 	<ul style="list-style-type: none"> Make sure that both video and sound inputs are correctly connected. Press the ◀ or ▶ button on the control panel or the remote control to hear the sound. Switch the MUTE function off by using the Mute button. Connect the external speakers and adjust the volume to a suitable level.
Some picture elements do not light up	Some pixels of the display may not turn on.	This display is manufactured using an extremely high level of precision technology: however, sometimes some pixels of the display may not display. This is not a malfunction.
After-Images can still be seen on the display after the display is powered off. (Examples of still pictures include logos, video games, computer images, and images displayed in 4:3 normal mode)	A still picture is displayed for an over extended period of time.	Do not allow a still image to be displayed for an extended period of time as this can cause a permanent after-image to remain on the display.

APPENDIX

6.5 Transporting the LCD Display

6.5.1 QX-32

To transport the LCD display for repair or shipment, place the display in its original packaging carton.

- 1 Put all the accessories in the accessory box (a) (if necessary).
- 2 Place the LCD display inside the foam cushion packaging (b).
- 3 Place the LCD display down in the box (c).
- 4 Place the accessories box on the designated area (if necessary).

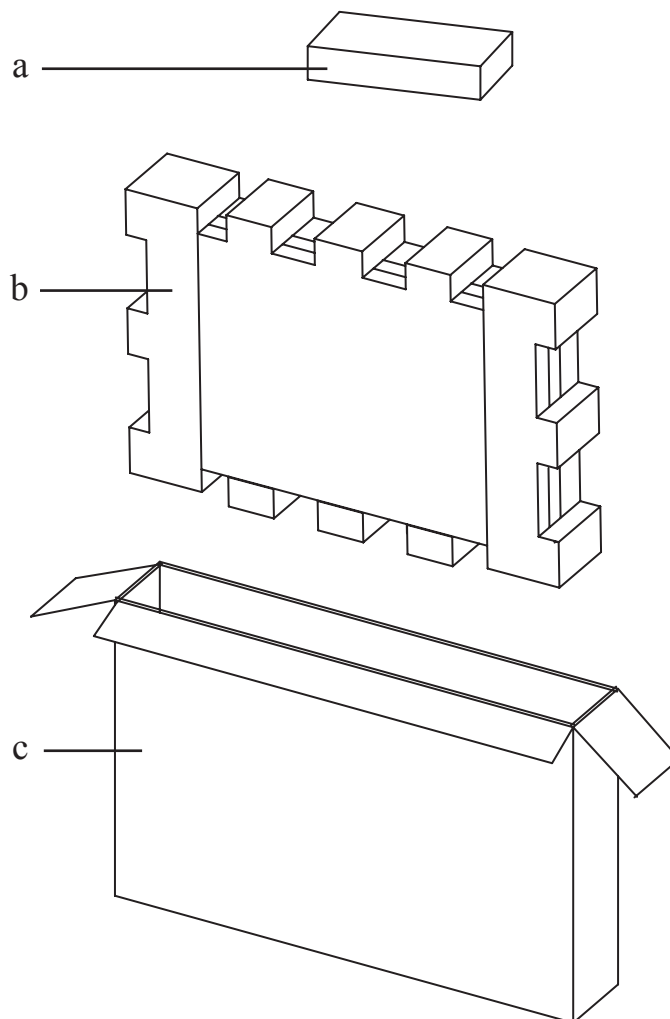

APPENDIX

6.5.2 QX-43 / QX-55

To transport the LCD display for repair or shipment, place the display in its original packaging carton.

- 1 Put all the accessories in the accessory box (a) (if necessary).
- 2 Place the LCD display inside the foam cushion packaging (b).
- 3 Place the LCD display down in the lower box (c).
- 4 Place the accessories box on the designated area (if necessary).
- 5 Place the upper box (d) on the LCD display.
- 6 Secure the upper box to the lower box with the supplied locks (e).

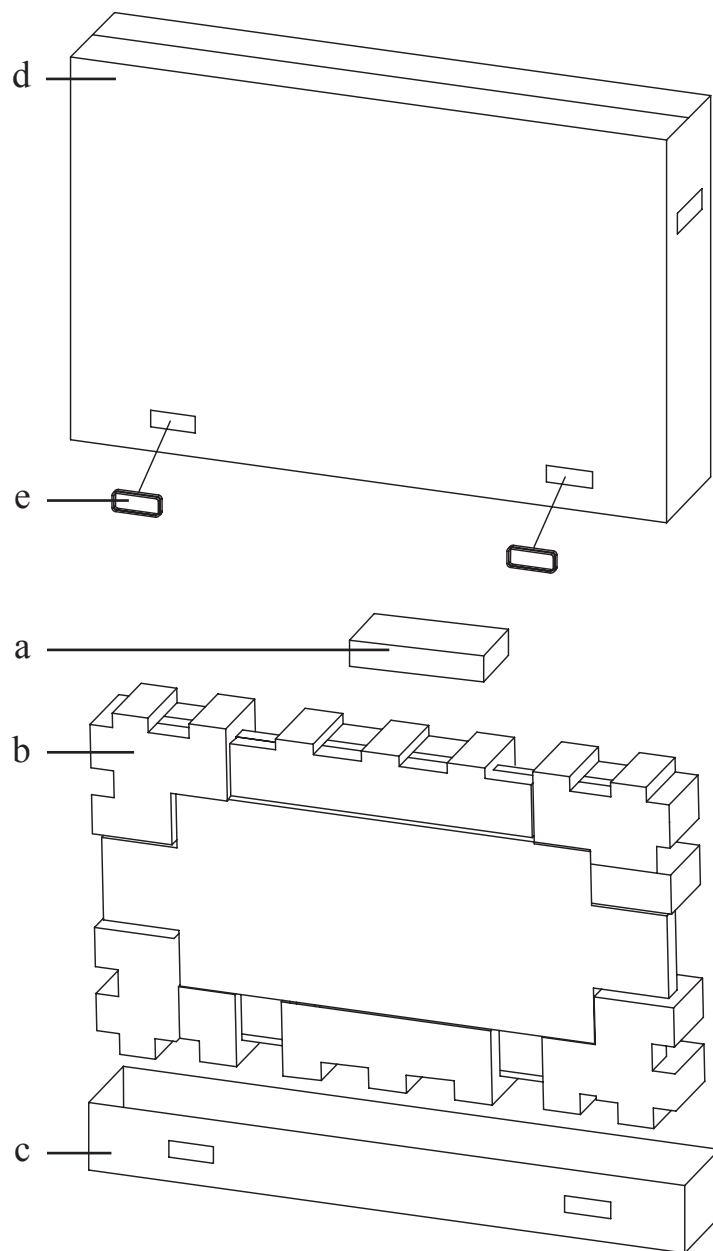

CHAPTER 7: SPECIFICATIONS

7.1 Display Specifications

Display	QX-32	QX-43	QX-55
Panel Type	LED-Backlit TFT LCD (MVA)		
Panel Size	32"	42.5"	55"
Max. Resolution	3840 x 2160 (UHD)		
Pixel Pitch	0.185 mm	0.245 mm	0.315 mm
Brightness	350 cd/m ²	500 cd/m ²	450 cd/m ²
Contrast Ratio	1,000 : 1	3,000 : 1	4,000 : 1
Viewing Angle (H/V)	178°/178°		
Display Colour	1.07 B	16.7 M	1.07 B
Response Time	5 ms		

Input	QX-32	QX-43	QX-55
VGA	15-Pin D-Sub		
DVI	24-Pin DVI-D		
HDMI	HDMI 2.0		
DisplayPort	DisplayPort 1.2a		
USB	For firmware update only		

External Control	QX-32	QX-43	QX-55
RS-232 In	9-PIN D-Sub Female		
RJ45	RJ45 8P8C		
IR	IR		

Audio	QX-32	QX-43	QX-55
Audio In	Stereo audio jack for PC (3.5mm) x 1		
Speaker	8W X 2		

Power	QX-32	QX-43	QX-55
Power Supply	Internal		
Power Requirements	100~240, 50Hz~60Hz		
Consumption	<85W (On)	<114W (On)	<160W (On)

NeoV™ Optical Glass	QX-32	QX-43	QX-55
Thickness	3mm (0.12")	4mm (0.16")	
Reflection Rate	< 1%		
Transmission Rate	≥97%		
Coating Hardness	9H		

Operating Conditions	QX-32	QX-43	QX-55
Temperature	0°C ~ 40°C (32°F ~ 104°F)		
Humidity	10%~90% (No condensation)		

Dimensions and Weight	QX-32	QX-43	QX-55
(W x H x D) (without base)	771.0 x 461.0 x 77.0 mm	1002.5 x 589.6 x 87.0 mm	1271.0 x 742.0 x 87.0 mm
(W x H x D) (packaging)	860.0 x 555.0 x 145.0 mm	1135.0 x 688.0 x 185.0 mm	1430.0 x 830.0 x 185.0 mm
Weight (without base)	15.7 kg	27.0 kg	39.1 kg
Weight (packaging)	19.0 kg	31.9 kg	47.2 kg

SPECIFICATIONS

Regional Approval	QX-32	QX-43	QX-55
Certifications & Compliance	CB, CE, RoHS, WEEE, REACH		
Dimensions and Weight	QX-32	QX-43	QX-55
Accessories	Power Cord, HDMI Cable, Remote Controller, Batteries, Quick Start Guide		

Note:

- ◆ All specifications are subject to change without prior notice.

SPECIFICATIONS

7.2 Display Dimensions

7.2.1 QX-32 Dimensions

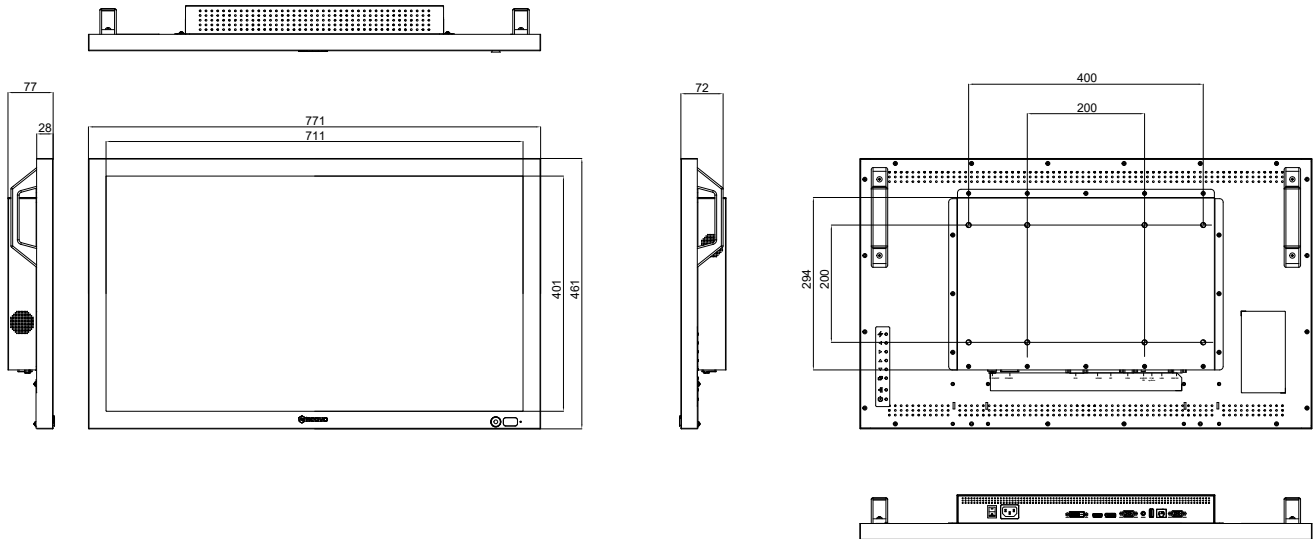

7.2.2 QX-43 Dimensions

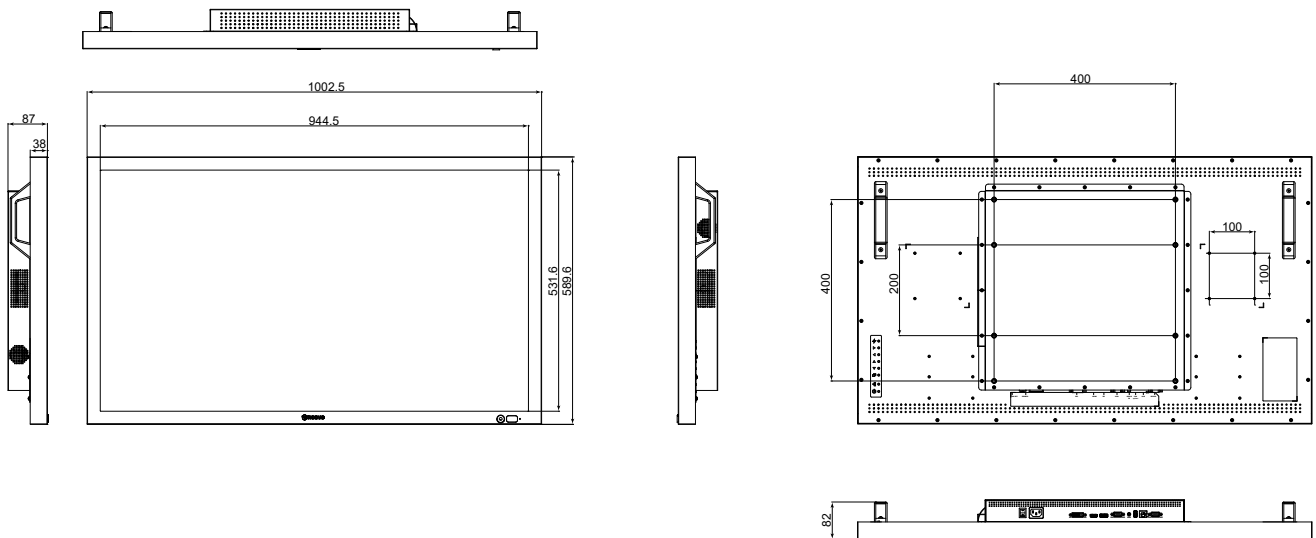

SPECIFICATIONS

7.2.3 QX-55 Dimensions

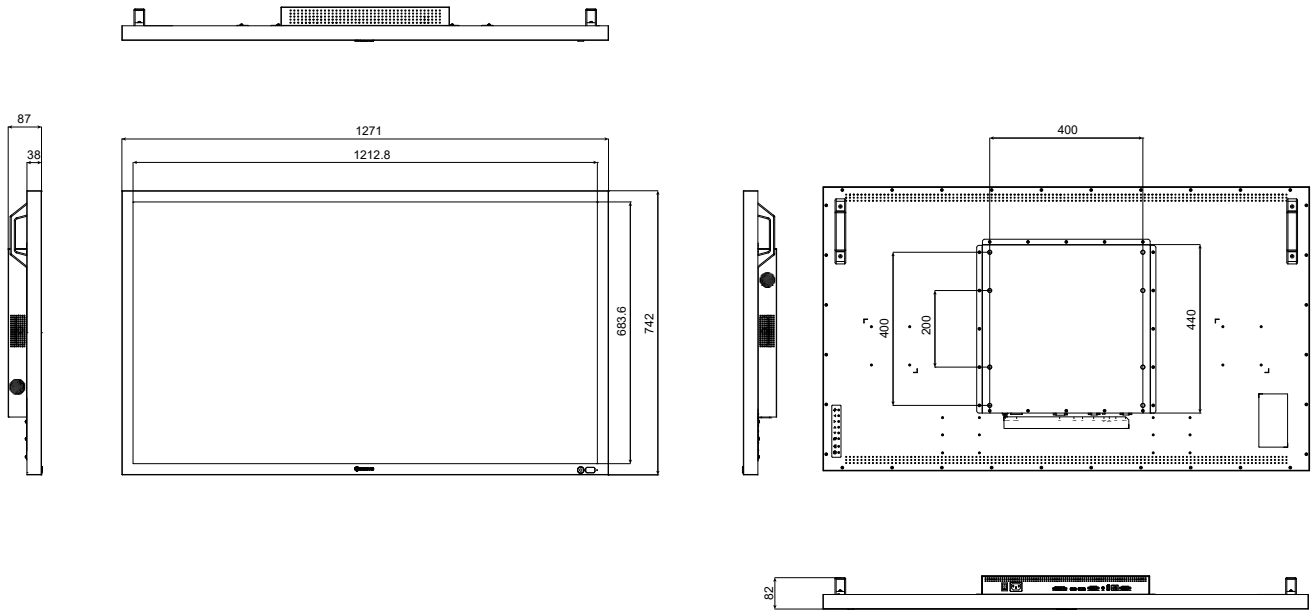

AG Neovo

Company Address: 5F-1, No. 3-1, Park Street, Nangang District, Taipei, 11503, Taiwan.

Copyright © 2017 AG Neovo. All rights reserved.

QX-32/QX-43/QX-55_UM_V010