

---

# INSTALLATION INSTRUCTIONS

---

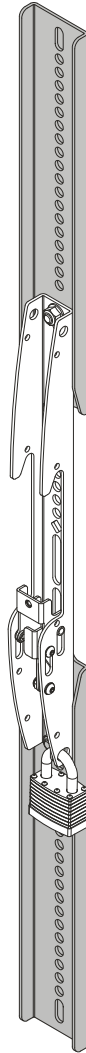

---

## 500mm Interface Adapter

---

**DISCLAIMER**

Milestone AV Technologies and its affiliated corporations and subsidiaries (collectively "Milestone"), intend to make this manual accurate and complete. However, Milestone makes no claim that the information contained herein covers all details, conditions or variations, nor does it provide for every possible contingency in connection with the installation or use of this product. The information contained in this document is subject to change without notice or obligation of any kind. Milestone makes no representation of warranty, expressed or implied, regarding the information contained herein. Milestone assumes no responsibility for accuracy, completeness or sufficiency of the information contained in this document.

Chief® is a registered trademark of Milestone AV Technologies. All rights reserved.

**DEFINITIONS**

**MOUNTING SYSTEM:** A MOUNTING SYSTEM is the primary Chief product to which an accessory and/or component is attached.

**ACCESSORY:** AN ACCESSORY is the secondary Chief product which is attached to a primary Chief product, and may have a component attached or setting on it.

**COMPONENT:** A COMPONENT is an audiovisual item designed to be attached or resting on an accessory or mounting system such as a video camera, CPU, screen, display, projector, etc.

 **WARNING:** A WARNING alerts you to the possibility of serious injury or death if you do not follow the instructions.

 **CAUTION:** A CAUTION alerts you to the possibility of damage or destruction of equipment if you do not follow the corresponding instructions.

 **IMPORTANT SAFETY INSTRUCTIONS**

 **WARNING:** Failure to read, thoroughly understand, and follow all instructions can result in serious personal injury, damage to equipment, or voiding of factory warranty! It is the installer's responsibility to make sure this accessory is properly assembled and installed using the instructions provided.

 **WARNING:** Failure to provide adequate structural strength for this accessory can result in serious personal injury or damage to equipment! It is the installer's responsibility to make sure the structure to which this accessory is attached can support five times the combined weight of all equipment. Reinforce the structure as required before installing the accessory.

 **WARNING:** Exceeding the weight capacity can result in serious personal injury or damage to equipment! It is the installer's responsibility to make sure the combined weight of all components attached to the FHB5106 does not exceed the weight limit of the mount to which it is being attached.

 **WARNING:** Use this accessory only for its intended use as described in these instructions. Do not use attachments not recommended by the manufacturer.

 **WARNING:** Never operate this accessory if it is damaged. Return the accessory to a service center for examination and repair.

 **WARNING:** Do not use this product outdoors.

**IMPORTANT ! :** The FHB5106 is designed for use on displays with mounting patterns up to 500mm.

**--SAVE THESE INSTRUCTIONS--**

**TOOLS REQUIRED FOR INSTALLATION / PARTS**

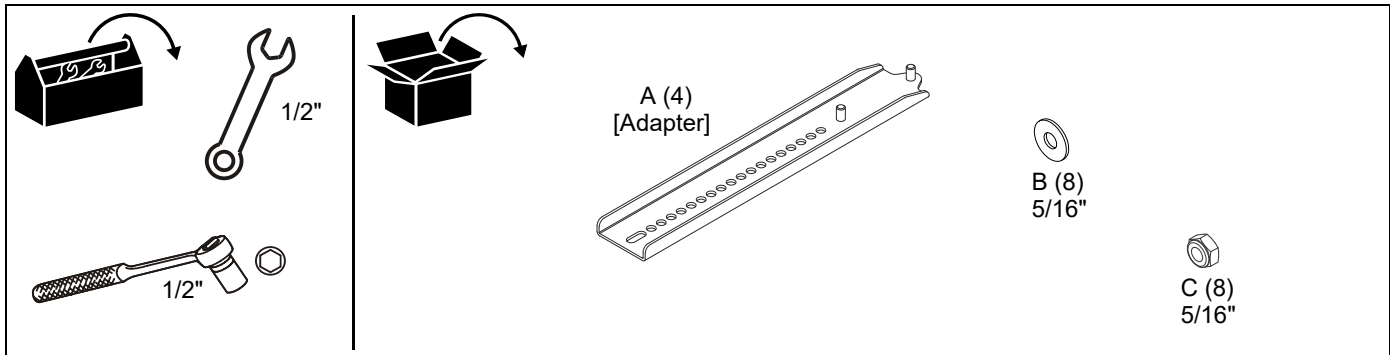

**DIMENSIONS**

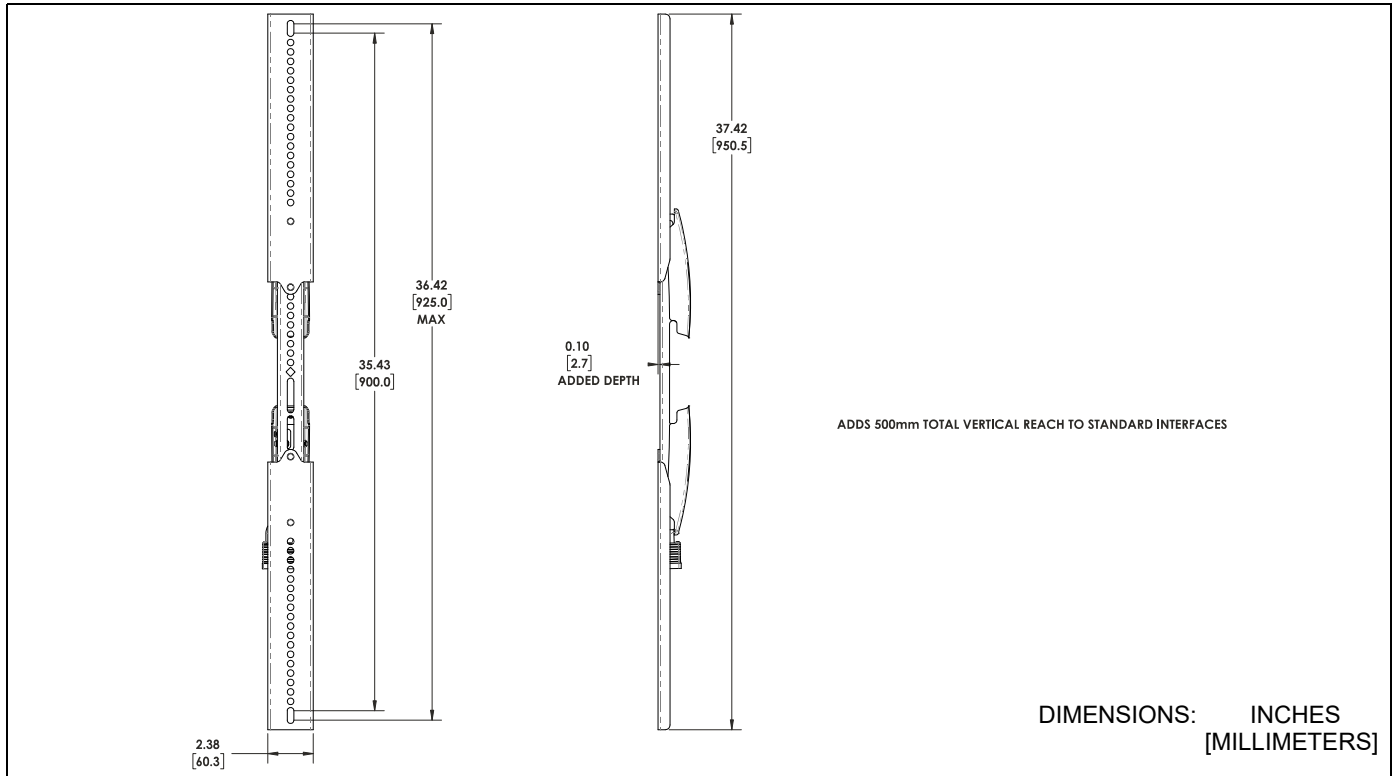

**ASSEMBLY AND INSTALLATION**

1. Attach the adapters (A) to the top and bottom of the mount's static or tilt uprights using two 5/16" washers (B) and two 5/16" hex nuts (C) on each adapter. (See Figure 1)
2. Complete the installation following the mount installation instructions.

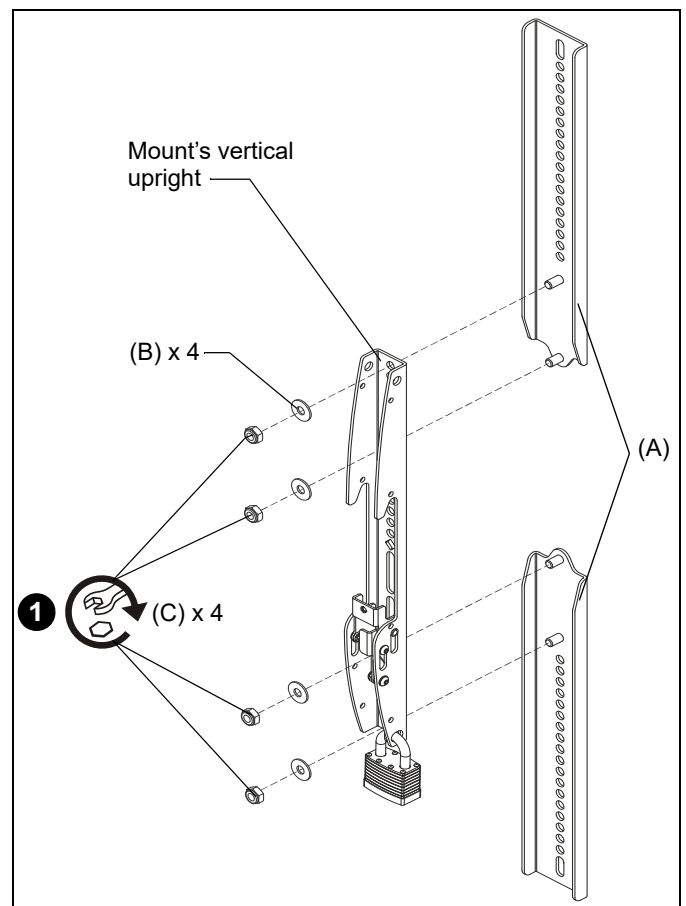

Figure 1



Our Mounts. **Your Vision.**

Chief, a products division of  
Milestone AV Technologies

8800-003101 Rev00  
©2018 Milestone AV Technologies  
[www.milestone.com](http://www.milestone.com)  
12/18

<b>USA/International</b>	<b>A</b> 6436 City West Parkway, Eden Prairie, MN 55344 <b>P</b> 800.582.6480 / 952.225.6000 <b>F</b> 877.894.6918 / 952.894.6918
<b>Europe</b>	<b>A</b> Franklinstraat 14, 6003 DK Weert, Netherlands <b>P</b> +31 (0) 495 580 852 <b>F</b> +31 (0) 495 580 845
<b>Asia Pacific</b>	<b>A</b> Office No. 918 on 9/F, Shatin Galleria 18-24 Shan Mei Street Fotan, Shatin, Hong Kong <b>P</b> 852 2145 4099 <b>F</b> 852 2145 4477

