

Universal Three Input TPS (HDBaseT™) Transmitter with Built in Event Manager



Part No: 9154 0013



Highlight Features

- 4K/UHD (30Hz RGB 4:4:4, 60Hz YCbCr 4:2:0) and 3D capabilities
- Extends DVI, HDMI or VGA + Audio + Ethernet + RS-232 + IR + GPIO over a single CAT5e-CAT7e cable up to 170 m distance*
- Event Manager
- 10/100 Ethernet extension
- Bi-directional RS-232 and IR
- IR and RS-232 connection supports command injection
- GPIO control port
- Embeds analog audio

UMX-TPS-TX130 transmits universal 4K video, audio and control up to a 170 m distance over a single CAT cable. This transmitter was designed for digital and analog video and audio signals: DVI, VGA, YPrPb and HDMI1.4 with analog stereo audio from local input or embedded 7.1 HBR audio. It also handles HDCP encryption. Analog signals (both audio and video) are converted into a digital format and can be transmitted separately from each other. The unit offers bi-directional and transparent IR, RS-232 and Ethernet transmission. Both the IR and RS-232 connections support command injection, allowing it to send any IR or RS-232 control command directly from the LAN connection.

Remote powering is available through a single CAT cable, but local power supply can also be used. UMX-TPS-TX130 is compatible with both HDBaseT™** extenders and matrix boards.

* Depends on cable category and quality

**For further details see page 6

HDBaseT™ and the HDBaseT Alliance logo are trademarks of the HDBaseT Alliance

Standalone Application

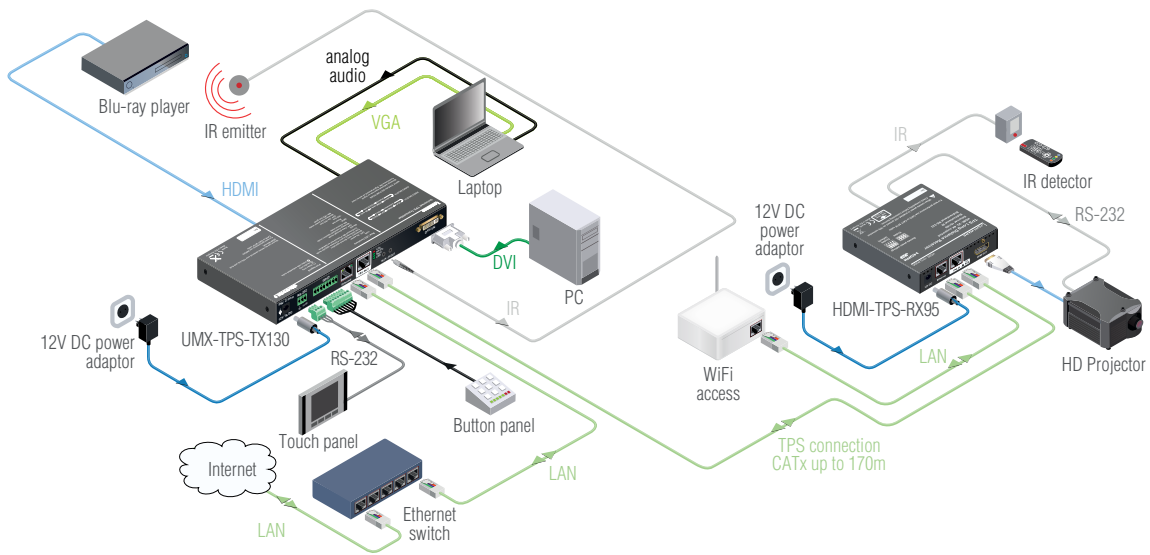

Application Diagram

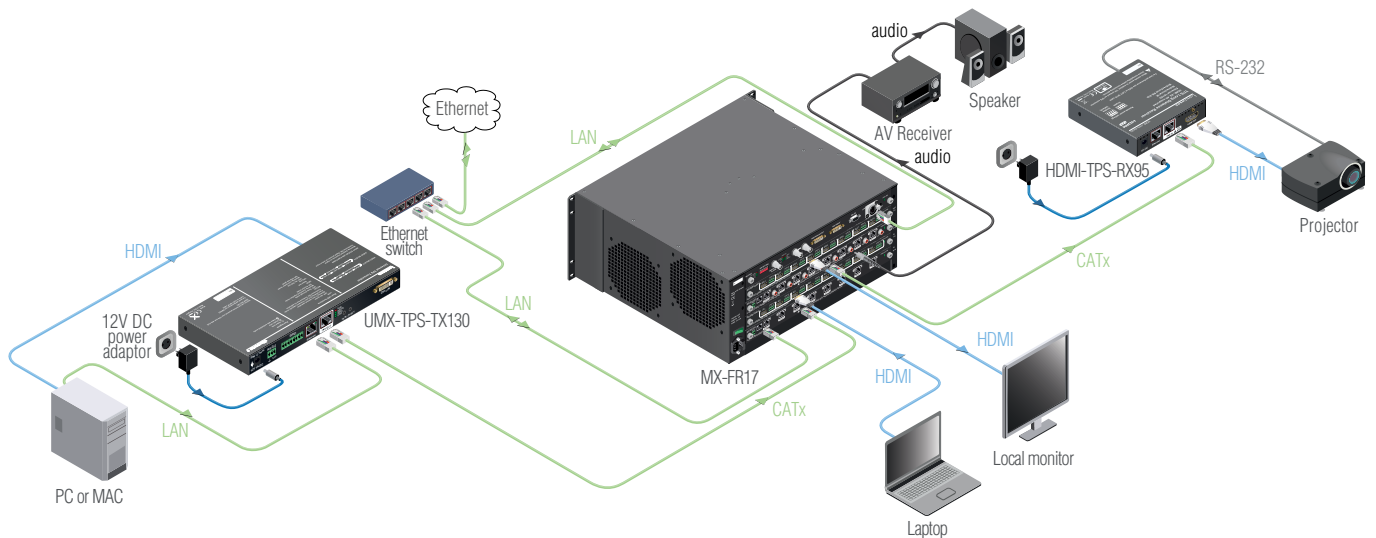

Max Cable Lengths Supported by the Available Firmware Versions

| Resolution | Pixel Clock Rate | Cable Lengths (Auto / Longreach TPS mode) | | |
|-------------------------|------------------|---|---------------|----------------|
| | | CAT5e AWG24 | CAT7 AWG26 | CAT7 AWG23 |
| 1024x768@60Hz | 65 MHz | 100 m / 130 m* | 90 m / 120 m* | 120 m / 170 m* |
| 1280x720p@60Hz | 73.8 MHz | 100 m / 130 m* | 90 m / 120 m* | 120 m / 170 m* |
| 1920x1080p@60Hz / 24bpp | 148.5 MHz | 100 m / 130 m* | 90 m / 120 m* | 120 m / 170 m* |
| 1920x1200@60Hz | 152.9 MHz | 100 m / NA* | 90 m / NA* | 120 m / NA* |
| 1600x1200@60Hz | 162 MHz | 100 m / NA* | 90 m / NA* | 120 m / NA* |
| 1920x1080@60Hz / 36bpp | 223 MHz | 70 m / NA* | 70 m / NA* | 100 m / NA* |
| 3840x2160@30Hz UHD** | 297 MHz | 70 m / NA* | 70 m / NA* | 100 m / NA* |
| 4096x2160@30Hz 4K** | 297 MHz | 70 m / NA* | 70 m / NA* | 100 m / NA* |

Above values are valid when the extender is powered by a local adaptor; distances may decrease depending on the powering mode (local or remote) and cable quality.
* with Long reach operation mode which supports pixel clock frequencies up to 148,5 MHz.

** if 4K video is selected to the output, analog audio cannot be embedded to the video stream due to the capabilities of the video IC, thus the original audio stream is transmitted.

Event Manager

The Event Manager is a completely new feature of Lightware's UMX-TPS extender family. It's available through the Lightware Device Controller and can be configured to detect LW3 protocol CHANGE messages. The Event Manager was developed to handle tasks from the most simple; like displaying internal events on GPIO ports, and controlling the extender via GPIO inputs instead of front panel pushbuttons; to expert ones like controlling the rolling shutter, the air conditioning system or the lights based on any condition changes on the media ports, such as a new source being connected or removed. The Event Manager makes the UMX-TPS extender family an expert solution in a wider range of applications.

Event Manager Wizard

Assigning an action to a condition is quick and easy with the Event Manager's smart Wizard function. The user can choose from the given port options in the dropdown menu and also add expressions to it.

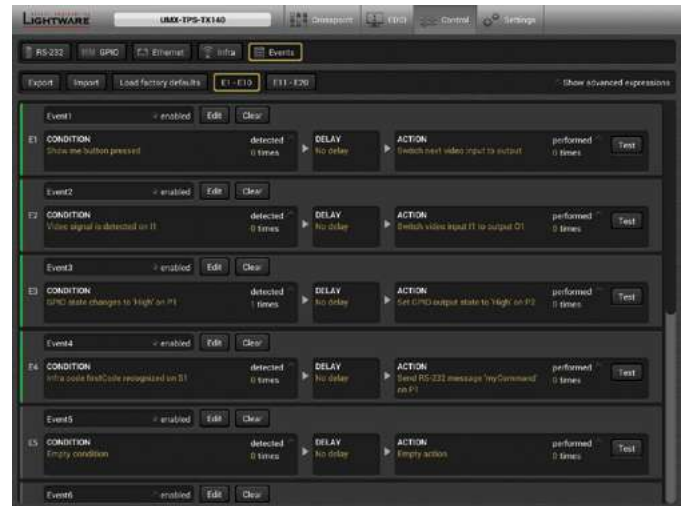

The Events menu contains 20 separately configurable Events



The Event Wizard makes the setup easy with simple dropdown options

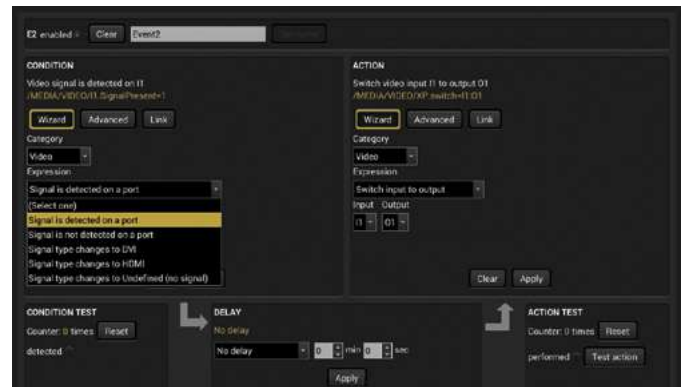

There are many default Expressions available to choose from

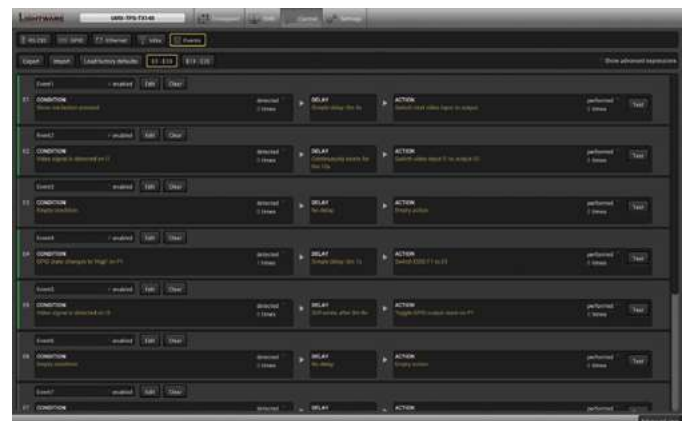

Green lines show which Event is configured and active, the rest stay grey

Event Example A

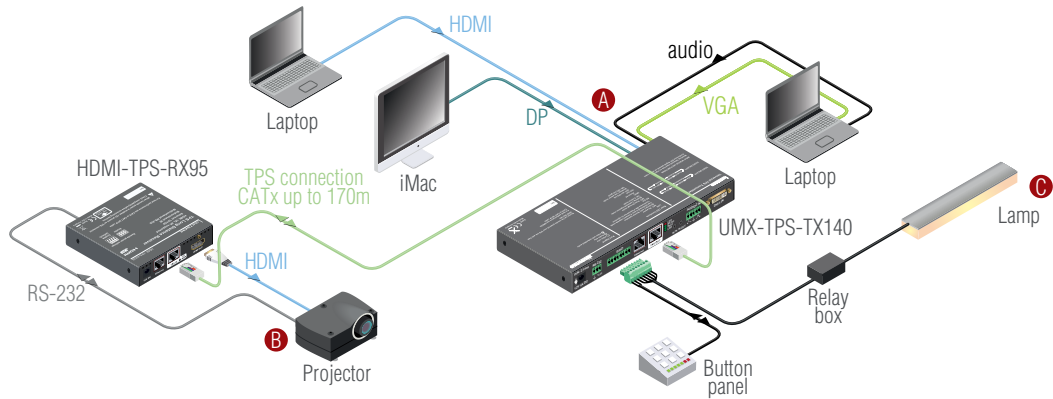

| Condition | Action |
|-----------|----------------------------------|
| | A Input select |
| | B Projector switch on |
| | C Lamp switch off |

With a connected button panel through the GPIO port the UMX-TPS-TX140 can be controlled from a remote location, input switching is available even if the transmitter mounted underdesk. In the example above there are three actions followed by a condition. When an input selector button is pressed on the remote button panel, the input port is switched to the selected one, the lamp switches off, and the projector turns on as well.

Event Example B

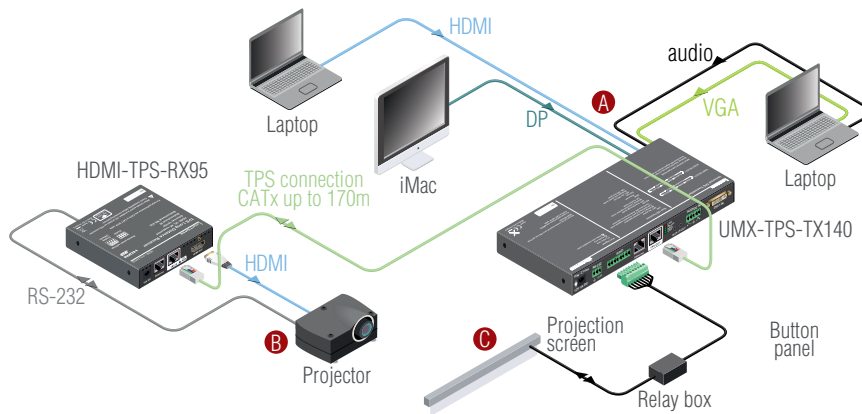





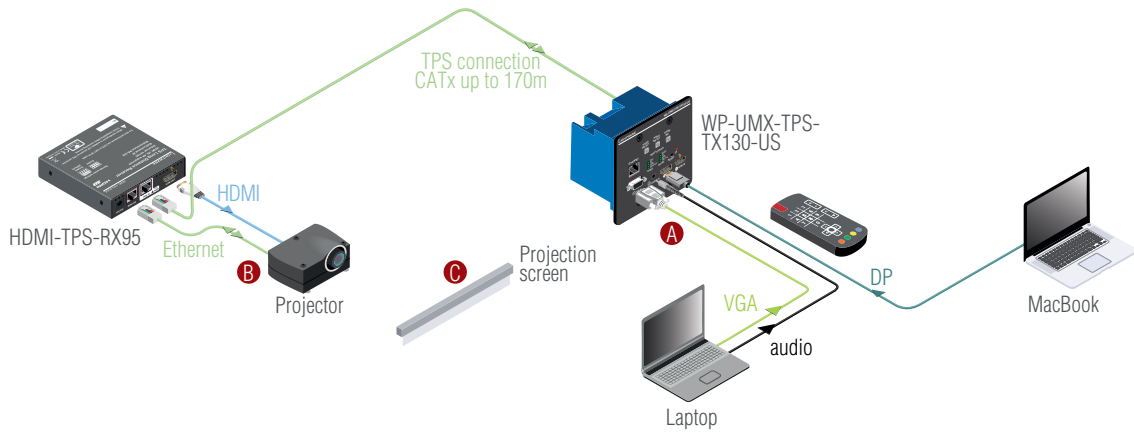

| Condition | Action |
|-----------|----------------------------------|
| | A Input select |
| | B Projector switch on |
| | C Screen down |

The projector and the rolling screen (through the Relay box) are connected to the UMX-TPS-TX140. When the user connects a laptop through HDMI to the transmitter the connected input is selected automatically the screen goes down and the projector turns on to display the connected source.

Event Example C



| Condition | Action |
|---|--|
|  |  A Input select |
|  Press remote controller |  B Projector switch on |
|  |  C Screen down |

A MacBook with DisplayPort and another laptop with VGA and analog audio are connected to the WP-UMX-TPS-TX130-US wallplate which means there are two audio signals and two video signals connected. With a remote controller via IR these inputs can be switched. For example the analog audio of the Laptop can be mixed with the DisplayPort video of the MacBook. The Event Manager helps the user to assign actions like rolling the screen down and switch the projector on when the desired input is selected.

Applications

- Small classrooms
- Conference rooms, meeting rooms
- Control room
- Home cinema

Features

- 4K/UHD (30Hz RGB 4:4:4, 60Hz YCbCr 4:2:0) and 3D capabilities
- Extends DVI, HDMI or VGA + Audio + Ethernet + RS-232 + IR + GPIO over a single CAT5e-CAT7e cable up to 170 m distance*
- Event Manager
- 10/100 Ethernet extension
- Embedded 7.1 HBR audio support
- Separate audio and video transmission
- Autoselect mode: video and audio priority modes
- Intuitive Control Software
- Bi-directional RS-232 and IR
- IR and RS-232 connection supports command injection
- GPIO control port
- HDCP compliant, CEC, EDID transparent
- Embeds analog audio
- HDBaseT™ compatibility
- Advanced EDID management
- No signal latency
- Frame detector
- Remote powering through CAT cable

*Depends on cable category and quality

Compatible Products

- MX Modular matrix frames with MX-TPS-IB
- HDMI-TPS-RX90
- MODEX TPS family
- DVI-HDCP-TPS-RX95
- HDMI-TPS-RX95

Specification

| | |
|----------------------------|--|
| Resolution: | Up to 4K UHD 3840x2160@30Hz, 1600x1200@60Hz, FullHD 1920x1080@60Hz |
| Digital audio formats: | Supports up to 8 channel PCM, Dolby TrueHD and DTS-HD Master Audio 7.1 formats |
| Input cable equalization: | Automatic max 20 m |
| EDID emulation: | Yes, Advanced EDID Management |
| EDID memory: | 119 factory preset, 15 user programmable |
| VGA to digital conversion: | 0 microseconds delay |
| HDCP pass-through: | Yes |
| RS-232 pass-through: | Yes, configurable |
| RS-232 (control option): | 9600, 19200, 38400, 57600, 115200 Baud Rx,Tx (local or through CATx)(default: 57600) |
| Local power: | Universal power adaptor, DC 12V 2.5A |
| Power over TPS: | DC 48V 1 A |
| Power consumption: | 8W (typ) |
| Enclosure: | 1 mm metal |
| Dimensions: | 221 W x 100.4 D x 26 H mm |
| Net weight: | 642 g |
| Compliance: | CE |
| Warranty: | 3 years |

Connectors

| | |
|----------------------|-------------------------------------|
| Digital video input: | HDMI connector, DVI-I connector |
| Analog video input: | VGA connector |
| Audio input: | Stereo jack |
| Ethernet: | 1 x RJ45 |
| TPS output: | 1 x RJ45 |
| Control: | 7 x GPIO, IR |
| Serial port: | 3-pole PHOENIX |
| Power: | Locking DC connector (2.1 / 5.5 mm) |

Analog Audio Input

| | |
|----------|-------------|
| Volume: | -96 .. 0 dB |
| Balance: | 0 .. 100% |

Transmitter Front and Back View



UMX-TPS-TX130

Port Diagram

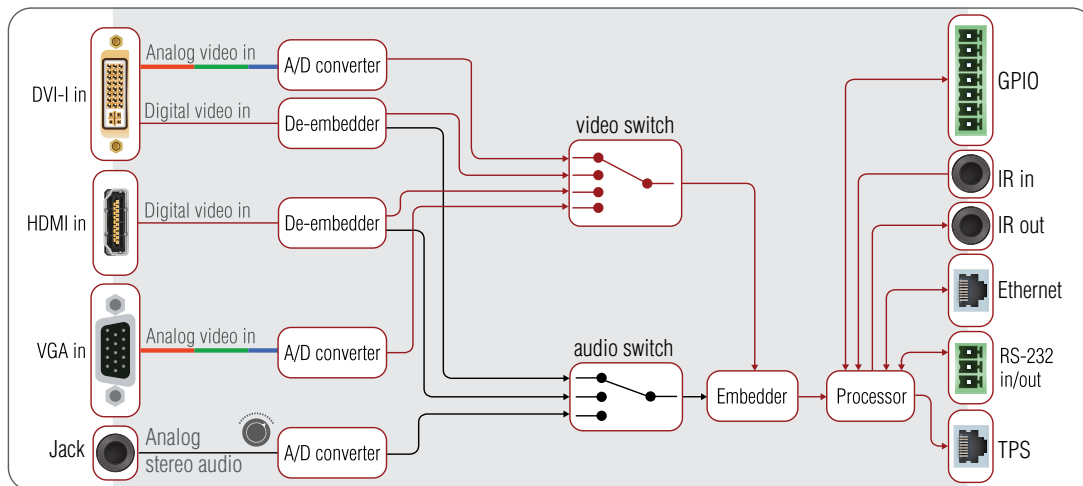

Supplied Accessories



PSU-12VU Universal DC adaptor (Part No: 1180 0098)
Wall power adaptor with interchangeable plug for international use.
Universal input: 100-240 V AC, 50-60 Hz, output: 12 V DC, 2.5 A



IR emitter and IR eye (Part No: 1374 0003 TX, 1374 0002 RX)
IR emitter is supplied with TPS-TX, IR eye is supplied with TPS-RX units. Needed for IR extension.

Optional Accessories



Under desk mounting kit double (Part No: 5240 0276)
The UD-kit double makes it easy to mount multiple devices on any flat surface (e.g. furniture).



Rack shelf (Part No: 5240 0935)
1U high rack shelf provides mounting holes for fastening four quarter-rack sized units. Pocket sized devices can also be fastened on the shelf.