

Motorized projection screen for ceiling recessed installations



Product specifications:

- Ceiling recessed electrically operated projection screen 230 volt (50Hz) with a usage of no more than 0.43 Ampere (98.9 Watt).
- The motor is mounted on the left side in the steel casing with rubber dampers to reduce sound.
- The motor is mounted inside the roller, 4 wire, 26 rotations per minute, maintenance free, integrated brake and thermal overload cut-out.
- The 4 wire connection goes through the metal casing.
- The casing is galvanised on the inside and on the outside powder coated with a matte structure coating (RAL 9016).
- The roller with the projection surface is supplied fully mounted but can be removed on location for the protection of the projection surface.
- After installation the projection screen surface is reachable through the bottom of the casing.
- The bottom of the case can swing open through an easy and innovative unlocking mechanism.
- Install the screen case separate from the screen surface during the rough-in stages of construction.
- The Screen Surface Assembly includes the roller, motor and screen surface.
- The roller can be easily removed via a unique push-release mechanism.
- The triangular slat bar rolls into the case completely.
- The screen fabrics are flame retardant and seamless in the viewing area.
- The projection fabrics have a black backing.
- The projection surface has a standard black drop of 30 cm.
- Standard 3 position wall switch is supplied.
- The projection screen is CE marked and satisfies the strictest quality and safety requirements.
- Integrated RF receiver option: this version will have a 3 wire connection and will be supplied with a remote control.

Options:

- RF - Radio frequency: Includes built-in radio frequency receiver, making it possible to operate the screen using the supplied remote control. Standard remote control is supplied when selected this option.

Aspect Ratios:

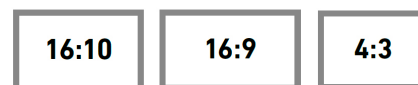

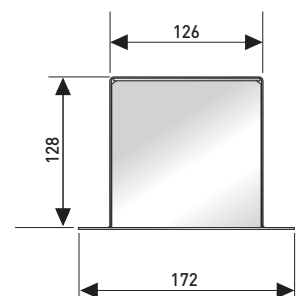

Available dimensions

Minimum width: 180 cm
Maximum width: 400 cm

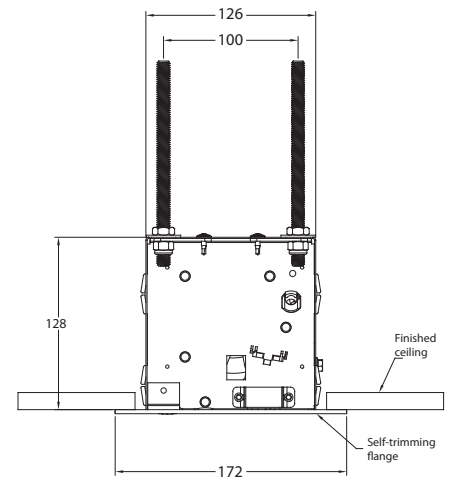
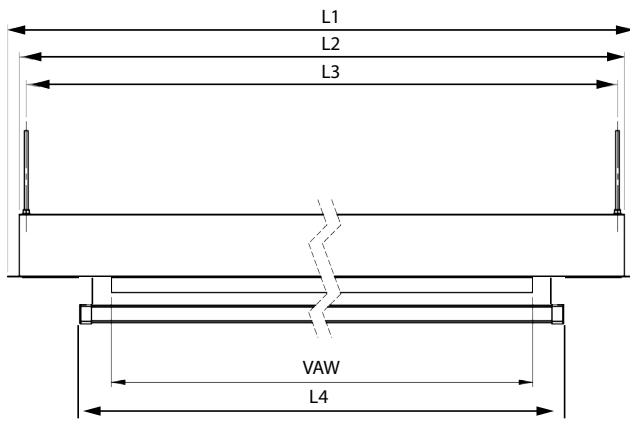

DESCENDERPRO



		DescenderPro				
		Viewing Area	Dimensions (mm)			
			cm	L1	L2	L3
16:10	200	119 x 190	2178	2148	2129	2040
	220	131 x 210	2378	2348	2329	2240
	240	144 x 230	2578	2548	2529	2440
	260	156 x 250	2778	2748	2729	2640
	280	169 x 270	2978	2948	2929	2840
	300	181 x 290	3178	3148	3129	3040
	320	194 x 310	3378	3348	3329	3240
	340	206 x 330	3578	3548	3529	3440
	360	219 x 350	3778	3748	3729	3640
	380	231 x 370	3978	3948	3929	3840
400	244 x 390	4178	4148	4129	4040	
16:9	200	107 x 190	2178	2148	2129	2040
	220	118 x 210	2378	2348	2329	2240
	240	129 x 230	2578	2548	2529	2440
	260	141 x 250	2778	2748	2729	2640
	280	152 x 270	2978	2948	2929	2840
	300	163 x 290	3178	3148	3129	3040
	320	174 x 310	3378	3348	3329	3240
	340	186 x 330	3578	3548	3529	3440
	360	197 x 350	3778	3748	3729	3640
	380	208 x 370	3978	3948	3929	3840
400	219 x 390	4178	4148	4129	4040	

Available standard resolution projection surfaces
All screen surfaces are seamless in the viewing area.

Matte White

Gain: 1.0
Viewing Angle: 120°
Base material: Fiberglass
Fire retardancy: B2
Black backing: Yes
Opacity rating: > 99 %
Seamless: Yes
GreenGuard certification: Yes



Standard: UL 2818 - 2013 Standard for Chemical Emissions for Building Materials, Finishes and Furnishings
Certification number: Greenguard - 4710-410
Greenguard Gold - 4710-420

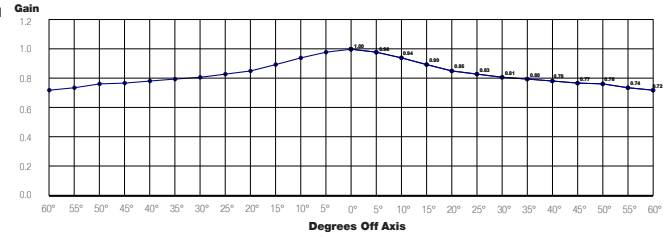

Datalux

Gain: 1.5
Viewing Angle: 70°
Base material: Fiberglass
Fire retardancy: B2
Black backing: Yes
Opacity rating: > 99 %
Seamless: Yes
GreenGuard certification: Yes



Standard: UL 2818 - 2013 Standard for Chemical Emissions for Building Materials, Finishes and Furnishings
Certification number: Greenguard - 4712-410
Greenguard Gold - 4712-420

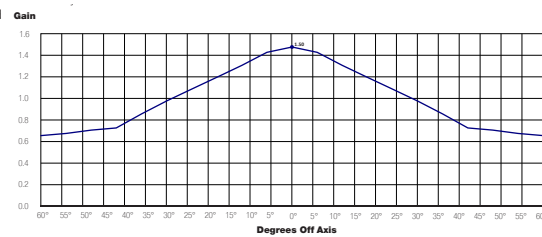

High Contrast

Gain: 1.1
Viewing Angle: 100°
Base material: Fiberglass
Fire retardancy: B2
Black backing: Yes
Opacity rating: > 99 %
Seamless: Yes
GreenGuard certification: Yes



Standard: UL 2818 - 2013 Standard for Chemical Emissions for Building Materials, Finishes and Furnishings
Certification number: Greenguard - 4708-410
Greenguard Gold - 4708-420

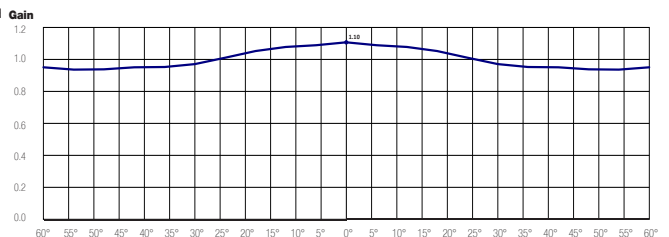

B1 / M1 Fire retardancy

Projection surface with B1 / M1 fire retardancy is optionally available. Contact Projecta for feasibility.

Certifications

- Products are manufactured in an ISO14001 certified facility
- Projecta is an ISO 9001 certified company
- REACH - Registration, Evaluation, Authorisation and Restriction of Chemical substances.
- RoHS - Restriction of Hazardous Substances.
- WEEE - Waste Electronic and Electrical Equipment Regulations.



Customisation

Give exact the sizes of the projection screen you need:

Viewing size: _____ Height (cm.) x _____ width (cm.)

Surface: _____ Border top: _____ (cm.) Border bottom: _____ (cm.)

RAL color case and plastic parts: RAL _____

Motor positioned on right side

Remarks: _____

Accessories - control options

For projection screens with a standard motor / delivered as standard with a wall switch

- All-in-One Control Box, which contains:
 - > Relay (dry contact)
 - > RF control, including remote control
 - > IR control, including remote control
 - > Manual switch
 - > 12v DC trigger
- Power Sensing Trigger (need All-in-One Box to function)
- Easy Install plug & play relaybox with potential free contacts
 - > Easy Install plug & play RS232/RS422 control kit
 - > Easy Install plug & play RS232/RS422 with IP control kit
- Keyswitch

For projection screens with an RF motor / delivered as standard with a remote control

- RF wall-mounted transmitter (433,92 Mhz)
- 4-channel RF remote control (433,92 Mhz)

Accessories - installation

- Ceiling brackets (100 cm.)
- Set extension brackets (75 cm.)
- Set extension brackets (30 cm.)



DescenderPro - 2-step Installation

After installation of the case, you can separately install the Screen Surface Assembly, which contains the roller, motor and screen surface.

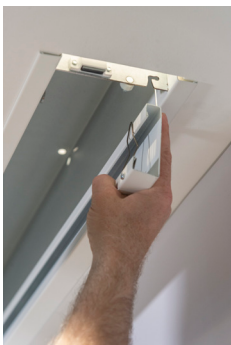

Warranty

Projecta provides a limited 5 year warranty on the DescenderPro + Elpro Concept range and a limited 2 year warranty on all other products. The warranty on the motor of electrical screens is 5 year. All warranties are in effect beginning the date the product was invoiced by Projecta.