

1 2 3 4

A

A

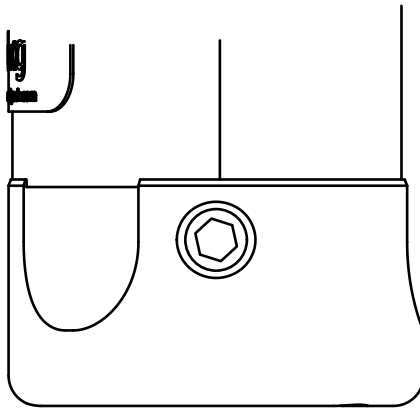

UTS / UTC product

B

B

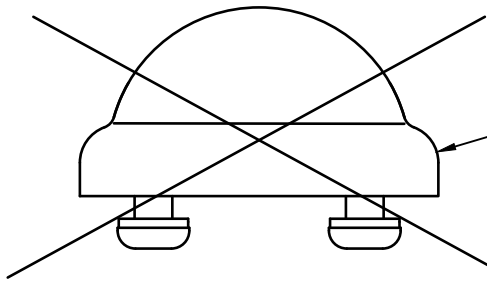

Remove existing cup

C

C

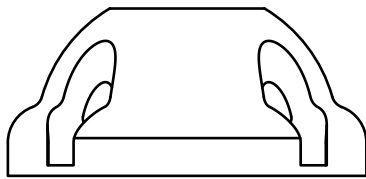

Replace with cup 701599



D

D

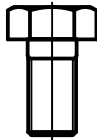

646283, interface to the camera

E

E

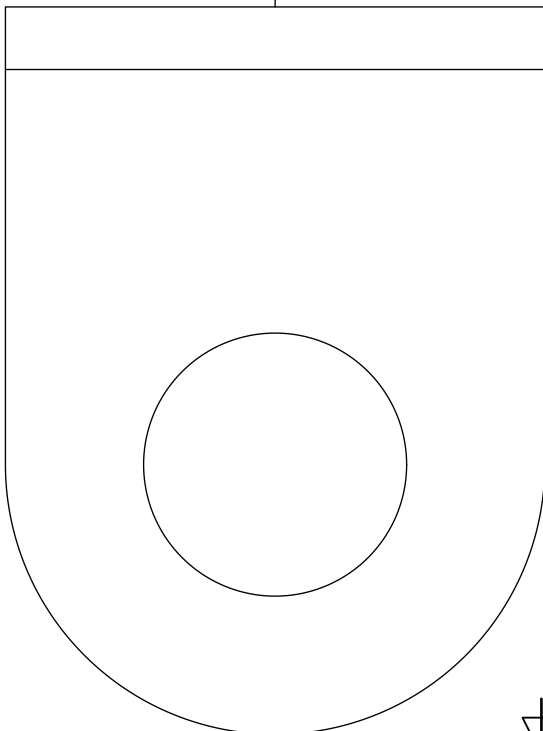



Camera

F

F

1

4

 <p>AUDIPACK Industriestraat 2 2721 GT, Hoofddorp The Netherlands Tel. +31(0)795931571 Fax. +31(0)795931575 www.Audipack.com</p>	Material:	TOLERANCES, UNLESS NOTED OTHERWISE: ISO 2768-m	
	Treatment:	Scale: 	Format: 
Drawn by: Name: Juul Date: 27-11-2020 Checked by: Appr. by:	Sheet: 1 of 1 1:1 A4		Part Number: P8205
Description: 1/4 UNC Camera interface			
<small>© COPYRIGHT AUDIPACK property of AUDIPACK It may not be delivered to others nor reproduced for general circulation without the written consent of the AUDIPACK engineering department</small>			