

Projector

mounts

Mount any brand and type of projector to any Audipack system.

Being one of the first to offer professional projector presentation accessories, Audipack products are state-of-the-art and are proven high quality.

The Audipack range of projector accessories and system varies from standard products, such as ceiling mounts, lifts and housings, to custom-built stack frames and flight cases with integrated lift systems.

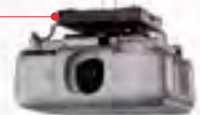
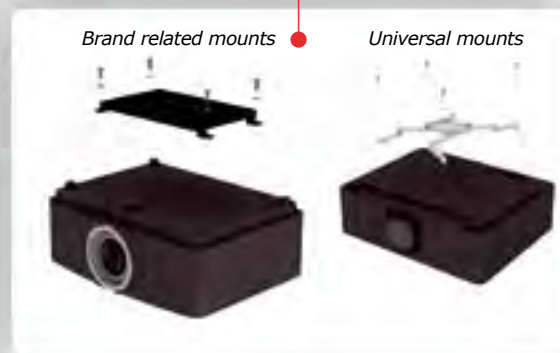

Audipack®









It's great to have solutions...

Mounts any **brands** and **type** of projector







With an Audipack projector mount, your projector is quickly and easily mounted to create a presentation solution. Audipack projector amounts are designed to precisely fit any brand or type of projector.

The interface makes it possible to swap projectors without the need to change the ceiling mount or lift. When necessary, switching the projector takes little time. Audipack designs and manufactures all mounts in-house and includes the manufacturers' recommendations in the product characteristics. The result is a perfect fit between mount and projector, ensuring the safest and most rigid product built.







QUATRO-FIX 1, 2 & 3

	Ref.	QFIX-1		
	Max. mounting range in mm	440		
	max. load	10-20 kg		
	Suitable for	Tube sets and products with ball-joint		
	Ref.	QFIX-2		
	Max. mounting range in mm	440		
	max. load	10-20 kg		
	Suitable for	Only for ceiling lifts		
	Ref.	QFIX-3		
	Max. mounting range in mm	100		
	max. load	20-30 kg		
	Suitable for	all purposes		

QUATRO-FIX 4 & 5

	Ref.	QFIX-4		
	Max. mounting range in mm	345 x 280		
	max. load	30 kg		
	Suitable for	large projector situations		
	Ref.	QFIX-5		
	mounting range in mm	min. 268 x 243 - max. 430 x 360		
	max. load	30 kg		
	Suitable for	large projector situations		

QUATRO-FIX 6 & 7

	Ref.	QFIX-6		
	mounting range in mm	min. 200 x 85 - max. 410 x 475		
	max. load	80 kg		
	Suitable for	large projector situations		
	Ref.	QFIX-7		
	Min - max mounting range in mm	200 x 85 - 620 - 735		
	Max. load	80 kg		
	Suitable for	large projector situations		

Ceiling mounts

for projectors

The projector is not only important element in a professional installation.

Features such as fast installation, easy adjustment and stability of any accessories are just as important.



Audipack®

It's great to have solutions...

Ultimate flexibility

with Audipack ceiling mounts



Quatro-Fix®, the allrounder

The Quatro-Fix projector mounts offers maximum flexibility to set up any projector up to 20kg within the most complex of installs.

The Quatro-Fix® ceiling mounts and the brand compatible mounts are equipped with a special newly designed ball joint that allows you to position the projector with minimal effort. The ball joint is designed to rotate from its own point of gravity. This results in a flexible and almost friction free adjustment capability.

UTS, for projector mounts and more.

Audipack also offers brand compatible projector mounts combined with the UTS (**U**niversal **T**ube **S**et) for any brand or type of projector, from stock. Brand compatible mounts are always a perfect fit and comply with manufacturers' installation guides and standards. For this type of ceiling mount an additional projector or camera mount is needed to complete the set.

UTS + brand related mount = the perfect solution



- ▲ **Rigid and safe construction**
- ▲ **Any configuration possible**
- ▲ **Very flexible**
- ▲ **Integrated cable ducts**

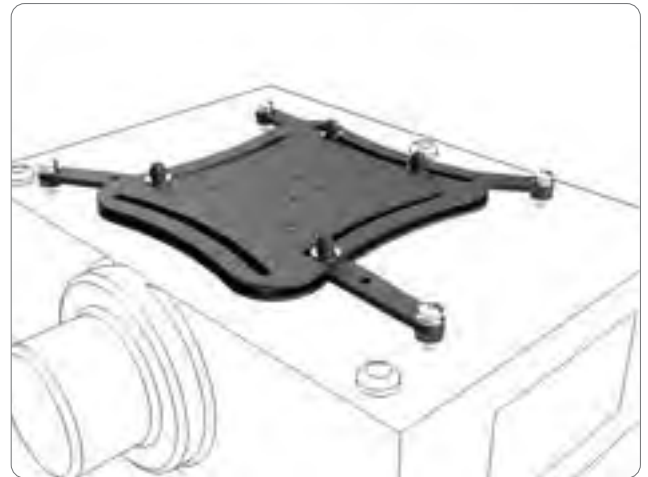

Angle adjustment

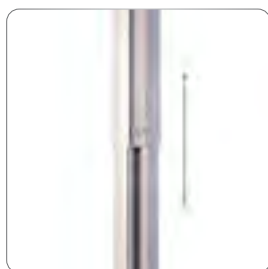

Perfect adjustment with telescopic feature

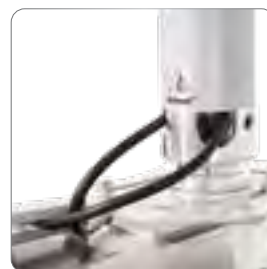

Cable passage



Cable passage

QUATRO-FIX

Max. load



Mounting range in mm
440 in diameter



Angle adjustment in degrees 15° + 15°

Ref. QFIX-0100

Length in mm 100
Tube diameter in mm 54



Ref. QFIX-0300

Length in mm 300
Tube diameter in mm 54



Ref. QFIX-0500T

Length in mm 355-500
Tube diameter in mm 54-60



Ref. QFIX-0700T

Length in mm 450-700
Tube diameter in mm 54-60



Ref. QFIX-1000T

Length in mm 604-1000
Tube diameter in mm 54-60



QUATRO-FIX XL

Max. load



20 Kg. 30 kg



Mounting range in mm
W336 x D 382



Angle adjustment in degrees 15° + 15°

Ref. QFIX3-0100

Length in mm 100
Tube diameter in mm 54



Ref. QFIX3-0300

Length in mm 300
Tube diameter in mm 54



Ref. QFIX3-0500T

Length in mm 355-500
Tube diameter in mm 54-60



Ref. QFIX3-0700T

Length in mm 450-700
Tube diameter in mm 54-60



Ref. QFIX3-1000T

Length in mm 604-1000
Tube diameter in mm 54-60



UNIVERSAL TUBE SET



Angle adjustment in degrees 15° + 15°

Ref. UTS-0100

Length in mm 100
Tube diameter in mm 54



Ref. UTS-0300

Length in mm 300
Tube diameter in mm 54



Ref. UTS-0500T

Length in mm 355-500
Tube diameter in mm 54-60



Ref. UTS-0700T

Length in mm 450-700
Tube diameter in mm 54-60



Ref. UTS-1000T

Length in mm 604-1000
Tube diameter in mm 54-60



Quick Release,

the perfect **AV** solution ...

Look no further for a ceiling mount that allows the fast and easy exchange of projectors. The quick release ball joint allows swift and safe installation.



HEAVY DUTY PROJECTOR CEILING MOUNT



Ref.	390065
Length in mm	164
Tube diameter in mm	45
Angle adjustment in degrees	20° + 20°



Ref.	390061
Length in mm	697-937
Tube diameter in mm	45-50
Angle adjustment in degrees	20° + 20°



QUICK RELEASE PROJECTOR CEILING MOUNT



Ref.	392165
Length in mm	142
Tube diameter in mm	45
Angle adjustment in degrees	30° + 30°



Ref.	392161
Length in mm	675-915
Tube diameter in mm	45-50
Angle adjustment in degrees	30° + 30°





The **heavy duty** universal ceiling mount is a TÜV certified rigid and strong ceiling mount suited for suspending projectors up to 70 kg from the ceiling. The ceiling mount is standard equipped with the patented Audipack ball-joint, which features the unique possibility **to line out** the projector to the projection screen. De cable-outlets enable a neat and safe installation of all the necessary connections.



The **Quick Release** ceiling mounts are ergonomic solutions especially designed for rental and stage use. The special releasable ball joint allows the projector up to 50 kg to be **installed quickly without any tools**. The ingenious construction releases the ball joint adjustment and makes swapping and positioning the projector easy.



The **Quick Release Plus** projector ceiling mounts are ergonomic solutions designed for rental and stage use. The special releasable ball joint allows the projector up to 50 kg to be **installed quickly without any tools**. The ingenious construction releases the ball joint adjustment and makes swapping and positioning the projector easy.

The Plus version has an additional adjustment platform with **3 adjustment knobs**, with which the projector position can be adjusted highly accurate. Ideal for those who use more than 1 projector in one and the same set up!

QUICK RELEASE PLUS PROJECTOR CEILING MOUNT WITH 3D ADJUSTMENT

	Ref.	392365	
	Length in mm	193	
	Tube diameter in mm	45	
	Angle adjustment in degrees	30° + 30°	
	Fine tune adjustment in degrees	-3°, +3°	
	Ref.	392361	
	Length in mm	726-966	
	Tube diameter in mm	45-50	
	Angle adjustment in degrees	30° + 30°	
	Fine tune adjustment in degrees	-3°, +3°	

QUICK RELEASE PLUS + TRUSS MOUNT WITH 3D ADJUSTMENT & HORIZONTAL SHIFT

	Ref.	392667	
	Length in mm	303	
	Angle adjustment in degrees	30° + 30°	
	Fine tune adjustment in degrees	-3°, +3°	
	Horizontal shift in mm	40	
	Ref.	392666	
	Length in mm	740 - 900	
	Angle adjustment in degrees	30° + 30°	
	Fine tune adjustment in degrees	-3°, +3°	
	Horizontal shift in mm	40	
	Ref.	392665	
	Length in mm	740 - 900	
	Angle adjustment in degrees	30° + 30°	
	Fine tune adjustment in degrees	-3°, +3°	
	Horizontal shift in mm	40	

Projector mount

for **vertical** positioning

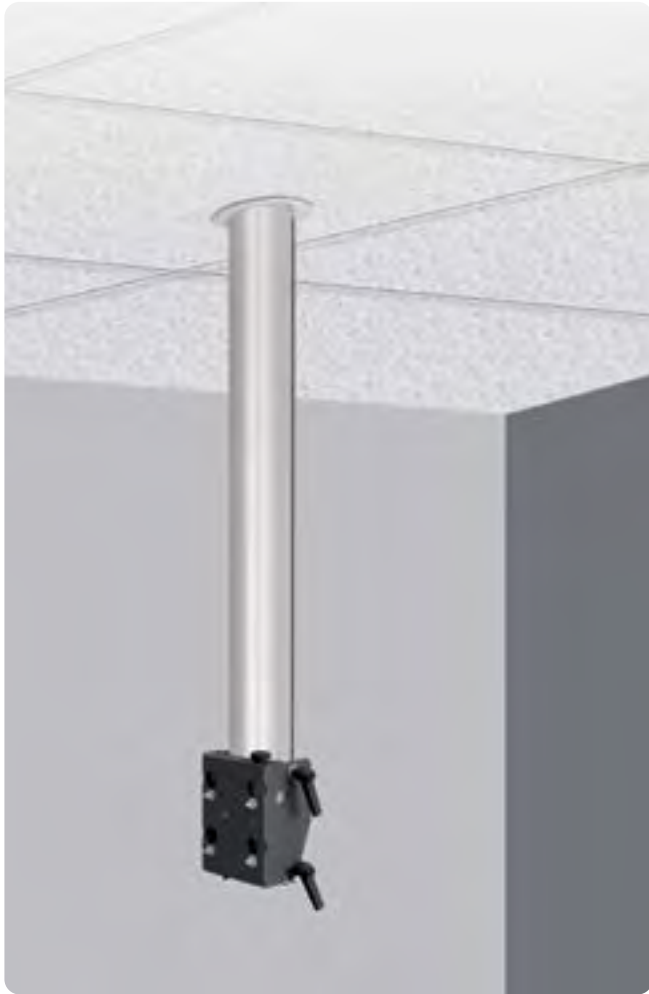

An elegant and rigid solution for installing projectors to the ceiling, with the minimalistic design well known from the 800 series product line.

This mount is specially designed for projectors with a special lens that allow a vertical installation.

The ceiling mount is equipped with features to line out the projector to the projection screen. De cable management system in the tube enables a neat and safe installation of all the necessary connections.

The mounting interface has a square 90 mm pattern on which the projector can be mounted. This is possible with the 392618 cams, which are included with the projecto ceiling mounts.

- ▲ **Slim and minimalistic design**
- ▲ **Easy cable management**
- ▲ **Available in many sizes**
- ▲ **Adjustable in heigth**

CEILING MOUNT FOR VERTICAL PROJECTION



CUSTOM-HEIGHT

Ref.	PCM-800-1000
Length in mm	1000
Tube	800 series with cable management
Angle adjustment in degrees	-3° + 7°
Mounting interface	L&S 4 - square pattern 90 mm



Ref.	PCM-800-XXXX
Length in mm	custom
Tube	800 series with cable management
Angle adjustment in degrees	-3° + 7°
Mounting interface	L&S 4 - square pattern 90 mm



ACCESSORIES

PROJECTOR MOUNTS

Mount any brand and type of projector on any Audipack system with the Audipack projector mounts.

When universal mounts are not applicable for projectors, brand related models are available.



QFIX mounts



Brand related mounts



EXTENSION TUBES (ONLY SUITABLE FOR HEAVY DUTY AND QUICK RELEASE TUBE SETS)

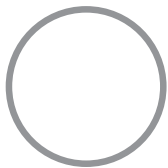

Diameter 45 mm.



Ref.	390022	390066	390367	390210	390321	390211
Length in mm	750	1000	1250	1500	1750	2000
Length gain in mm	350	600	850	1100	1350	1600

EQUIPMENT CABINET



For above ceiling installation



Ref.	EC-5
Max. equipment dimensions in mm	W 350 x D 350 x H 100

CEILING MOUNTS

SHOCK ABSORBER FOR CEILING MOUNTS



Ref.
Suitable for

392193
390065, 390061, 392165, 392161, 392365,
392361, 392665, 392661

TRUSS MOUNTS



Ref.
Suitable for

TM-54
54 mm (Q-fix & UTS only)

TM-60 (*Telescopic tube sets only*)
60 mm (Q-fix & UTS only)

260140
All "39....." products

SEVERAL OPTIONS



Ref.
Type
Suitable for

390199
Manual rotation
All "39....." tube sets

392150
Construction clamp
All

399941
Stainless steel security cable

Truss mounts

for projectors

Audipack truss mounts, ideal for rental & staging

Audipack truss mounts offer flexible installation options and secure features



Safe and solid

truss mounting

Do you need easy and quick projector truss mounting? Use the Audipack truss mounts!

Audipack offers a wide range of truss mountable projector mounts and solutions. To address different applications, Audipack offers specific solutions, from a simple projector mount to sophisticated 3D adjustment features. The mounts allow a quick and safe installation to be performed every time.

The **UTC range** offers a universal but very flexible and well-designed mounting range for projectors up to 30kg. Light weight, tolerance free and with integrated ball joints for perfect screen alignment.

The **Quick release** product line is distinguished by its unique separable ball joint and is the safest way for installing projectors up to 52kg to trusses. After installing the tube set, just click the projector to the tube set - 'click and go'.

Align the projector to the screen with the ball joint or even with the optional 3D adjustment (**QR-plus**) or linear adjustment (**QR-plus+**); ideal for seamless projection.



- ▲ **Fine pitch, pixel on pixel adjustment**
- ▲ **Rigid and safe construction**
- ▲ **Any configuration possible**
- ▲ **Very flexible**
- ▲ **Integrated cable ducts**



399941
Stainless steel
security cable

Quick release, the perfect AV rental solution ...

Look no further for a ceiling mount that allows the fast and easy exchange of projectors. The quick release ball joint allows swift and safe installation. Especially designed for professional rental and stage use.

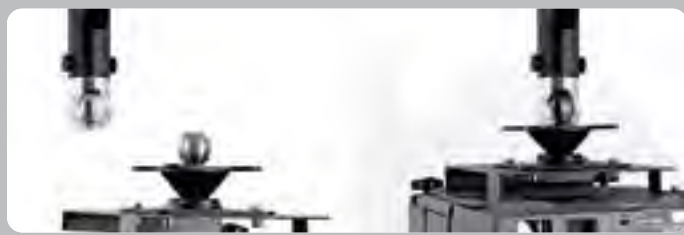

Perfect adjustment with
telescopic feature

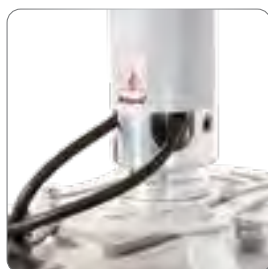







Cable passage



Cable passage





TRUSS MOUNTS WITH STANDARD BALL JOINT



Ref.	UTC-0150B		
Length in mm	150		
Angle adjustment in degrees	15° + 15°		
Ref.	UTC-0300B		
Length in mm	300		
Angle adjustment in degrees	15° + 15°		
Ref.	UTC-1000TB		
Length in mm	604-1000		
Angle adjustment in degrees	15° + 15°		





QUICK RELEASE TRUSS MOUNT



Ref.	392167		
Length in mm	252		
Angle adjustment in degrees	30° + 30°		
Ref.	392166		
Length in mm	760-1000		
Angle adjustment in degrees	30° + 30°		

QUICK RELEASE PLUS TRUSS MOUNT WITH 3D ADJUSTMENT



Ref.	392367		
Length in mm	303		
Angle adjustment in degrees	30° + 30°		
Fine tune adjustment in degrees	-3°, +3°		
Ref.	392366		
Length in mm	811-1051		
Angle adjustment in degrees	30° + 30°		
Fine tune adjustment in degrees	-3°, +3°		

TRUSS MOUNTS

PROJECTOR TRUSS MOUNT 800 SERIES



Ref.

Length in mm
 Tube
 Angle adjustment in degrees
 Mounting interface
 Compatibility

PTCV-800-XXXX

custom
 800 series with cable management
 -3° + 7°
 L&S 4 - square pattern 90 mm
 Audipack projector mounts



CUSTOM-HEIGHT

The 392618, additional cams are required for mounting.

ACCESSORIES

PROJECTOR MOUNTS

Mount any brand and type of projector on any Audipack system with the Audipack projector mounts.

When universal mounts are not applicable for projectors, brand related models are available.



QFIX mounts



Brand related mounts

EXTENSION TUBES (SUITABLE FOR THE UTC)

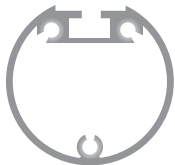

Diameter 54 mm.



Ref.	ET-1000	ET-1500	ET-2000	ET-2500
Length in mm	1000	1500	2000	2500
Length gain in mm	940	1440	1940	2440

EXTENSION TUBES (ONLY SUITABLE FOR QUICK RELEASE TUBE SETS)

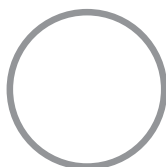

Diameter 45 mm.



Ref.	390022	390066	390367	390210	390321	390211
Length in mm	750	1000	1250	1500	1750	2000
Length gain in mm	350	600	850	1100	1350	1600



The BJ-PRO Ball-joints are heavy duty mounting solutions for installing projectors or equipment temporarily to trusses.

With the adjustable ball-joint the aiming direction of the projector can be adjusted and with the micro adjustment the projector can be aligned to the screen.

Installing the projector is easy, no tools needed! With the pre-installed Audipack bracket to the projector, the projector is installed and removed with the quick-release "¼ turn&lock" to the ball joint.

Safely store all your items in an Audipack flightcase.



BJ-PRO PROJECTOR TRUSS MOUNT



Ref. *BJ-PRO-BASIC single truss hook*

Height in mm	330
Angle adjustment in degrees	25° / 0° / 25°
Truss - diameter	50 mm



Ref. *BJ-PRO-1 single truss hook*

Height in mm	330
Angle adjustment in degrees	25° / 0° / 25°
Fine tune adjustment in degrees	5° / 0° / 5°
Truss - diameter	50 mm



Ref. *BJ-PRO-2 double truss hook*

Height in mm	330
Angle adjustment in degrees	25° / 0° / 25°
Fine tune adjustment in degrees	5° / 0° / 5°
Truss - diameter	50 mm



1 piece INT-1 is standard supplied with a ball-joint

TRUSS MOUNTS

BJ-PRO PROJECTOR TRUSS MOUNT**Ref. BJ-PRO-INT1**

Mounting interface 90 x 90 mm.

1 piece INT-1 is standard supplied with a ball-joint

**Ref. BJ-PRO-INT2**

Mounting interface 100 x 100 mm.

**QUATRO-FIX 4 & 5****Ref. QFIX-4**

Max. mounting range in mm. 345 x 280 mm.

Max. load 30 kg

Suitable for large projector situations

**Ref. QFIX-5**

Mounting range in mm. min. 268 x 243 - max. 430 x 360

Max. load 30 kg

Suitable for large projector situations

**QUATRO-FIX 6 & 7****Ref. QFIX-6**

Mounting range in mm. min. 200 x 85 - max. 410 x 475

Max. load 80 kg

Suitable for large projector situations

**Ref. QFIX-7**

Max. mounting range in mm. 200 x 85 - 620 - 735

Max. load 80 kg

Suitable for large projector situations



Short throw wall mounts

for projectors

The Audipack short throw wall mounts

are ideal to mount your projector directly on the wall or to an Audipack projection set up.



Audipack[®]

It's great to have solutions...

Easy installation with Audipack wall mounts

Audipack short throw wall mounts with universal projector mount is a most flexible yet durable solution.

Audipack short throw wall mounts have slim dimensions, a modern design and provide 100% tolerance free projector mounting. The easily accessible hidden cable ducts are ideal for hiding projector cabling and routing it to the wall.

The projector is mounted onto the famous Audipack Quatrofix, with a ball joint that allows for a rigid, steady projector mounting.

The short throw mount can be easily attached directly to the wall or onto a frame, whichever is the best solution for the projection screen.

- ▲ **Easy installation**
- ▲ **Rigid wall mounting**
- ▲ **Accurate projector adjustment**
- ▲ **Universal or brand related projector mounts**

SHORT THROW ARMS



Ref. PWM-ST0600

Adjustment range in mm 360-600
Max. mounting range in mm 440 in diameter



Ref. PWM-ST1200

Adjustment range in mm 960-1200
Max. mounting range in mm 440 in diameter



Ref. PWM-ST0800T

Adjustment range in mm 500-800
Max. mounting range in mm 440 in diameter



Ref. PWM-ST1500T

Adjustment range in mm 800-1500
Max. mounting range in mm 440 in diameter



Including Universal Quatro-Fix



WALL MOUNT



Ref. PWM-0450

Length in mm 450
See page for 123 for a projector mount, to mount your projector

